

Rider's Manual

K 1200 GT



BMW Motorrad



The Ultimate Riding
Machine

Motorcycle data/dealership details

Motorcycle data

Model

Vehicle identification number

Colour code

Date of first registration

Registration number

Dealership details

Person to contact in Service department

Ms/Mr

Phone number

Dealership address/phone number (company stamp)

Welcome to BMW

We congratulate you on your choice of a motorcycle from BMW and welcome you to the community of BMW riders. Familiarise yourself with your new motorcycle so that you can ride it safely and confidently in all traffic situations.

Please read this Rider's Manual carefully before starting to use your new BMW motorcycle. It contains important information on how to operate the controls and how to make the best possible use of all your BMW's technical features.

In addition, it contains information on maintenance and care to help you maintain your motorcycle's reliability and safety, as well as its value.

If you have questions concerning your motorcycle, your authorised

BMW Motorrad dealer will gladly provide advice and assistance.

We hope that you will enjoy riding your BMW and that all your journeys will be pleasant and safe.

BMW Motorrad.

Table of Contents

You can also consult the index at the end of this Rider's Manual if you want to find a particular topic or item of information.

1 General instructions	5
Overview	6
Abbreviations and symbols	6
Equipment	7
Technical data	7
Currency	7
2 General views	9
General view, left side	11
General view, right side	13
Underneath the seat	15
Handlebar fitting, left	16
Handlebar fitting, right	17
Instrument cluster	18
Headlight	19

3 Status indicators	21
Standard status indicators	22
Status indicators with on-board computer ^{OE}	23
Status indicators with tyre-pressure monitoring (RDC) ^{OE}	24
Status indicators with seat heating ^{OE}	24
Telltale light with cruise control ^{OE}	25
Standard warnings	25
Warnings issued by the on-board computer ^{OE}	30
ABS warnings	32
ASC warnings ^{OE}	34
RDC warnings ^{OE}	36
Anti-theft alarm warnings ^{OE}	41

4 Operation	45
Ignition switch and steering lock	47
Electronic immobiliser	48
Clock	49
Odometer and tripmeters	49
Multifunction display	51
On-board computer ^{OE}	51
Tyre pressure monitoring RDC ^{OE}	54
Lights	55
Turn indicators	56
Hazard warning flashers	57
Emergency off switch (kill switch)	58
Grip heating ^{OE}	59
Seat heating ^{OE}	60
Automatic Stability Control ASC ^{OE}	61
Seat height	62
Windscreen	63
Cruise-control system ^{OE}	63
Stowage compartment	66
Clutch	66

Brakes	67	6 Engineering details.....	89	Front-wheel stand.....	121
Handlebars	67	Brake system with BMW Mo-		Bulbs.....	123
Mirrors	68	torrad Integral ABS.....	90	Jump starting	131
Spring preload	68	Electronic engine manage-		Battery	132
Damping	69	ment with BMW Motorrad		9 Care.....	137
Electronic Suspension Ad-		ASC ^{OE}	92	Care products.....	138
justment ESA ^{OE}	69	Tyre pressure monitoring		Washing motorcycle.....	138
Tyres.....	72	RDC ^{OE}	94	Cleaning easily damaged	
Headlight.....	72	7 Accessories	97	components.....	138
Front and rear seats.....	73	General instructions	98	Paint care	139
Helmet holder	76	Power socket	98	Protective wax coating	140
5 Riding.....	77	Luggage	99	Laying up the motor-	
Safety instructions	78	Case	100	cycle	140
Checklist	80	Topcase ^{OA}	102	Restoring motorcycle to	
Starting.....	80	8 Maintenance	105	use.....	140
Running in	83	General instructions	106	10 Technical data	141
Brakes	84	Toolkit.....	106	Troubleshooting chart.....	142
Parking your motorcycle	85	Engine oil	107	Threaded fasteners	143
Refuelling	87	Brake system, general.....	109	Engine	145
		Brake pads	109	Fuel	146
		Brake fluid.....	111	Engine oil	146
		Clutch.....	113	Clutch.....	147
		Tyres.....	113	Transmission.....	147
		Rims	114	Rear-wheel drive	148
		Wheels	114	Running gear.....	148

Brakes	149
Wheels and tyres.....	149
Electrics.....	150
Frame	152
Dimensions	152
Weights	153
Riding specifications	153
11 Service	155
BMW Motorrad service.....	156
BMW Motorrad service quality	156
BMW Motorrad Service Card: on-the-spot break- down assistance	156
BMW Motorrad service net- work.....	157
Maintenance work.....	157
Confirmation of mainten- ance work	158
Confirmation of service.....	163

General instructions

Overview	6
Abbreviations and symbols	6
Equipment	7
Technical data	7
Currency	7

Overview

Chapter 2 of this Rider's Manual will provide you with an initial overview of your motorcycle. All maintenance and repair work on the motorcycle is documented in Chapter 11. This record of the maintenance work you have had performed on your motorcycle is a precondition for generous treatment of goodwill claims.

When the time comes to sell your BMW, please remember to hand over this Rider's Manual; it is an important part of the motorcycle.

Abbreviations and symbols



Indicates warnings that you must comply with for reasons of your safety and the safety of others, and to protect your motorcycle against damage.



Specific instructions on how to operate, control, adjust or look after items of equipment on the motorcycle.



Indicates the end of an item of information.



Instruction.



Result of an activity.



Reference to a page with more detailed information.



Indicates the end of a passage relating to specific accessories or items of equipment.



Tightening torque.



Item of technical data.

OE

Optional extra
The motorcycles are assembled complete with all the BMW optional extras originally ordered.

OA

Optional accessory
You can obtain optional accessories through your authorised BMW Motorrad dealer; optional accessories have to be retrofitted to the motorcycle.

EWS

Electronic immobiliser (Elektronische Wegfahrsicherung).

DWA

Anti-theft alarm (Diebstahlwarnanlage)

ABS

Anti-lock brake system

ASC

Automatic Stability Control.

ESA Electronic Suspension Adjustment
Electronic Suspension Adjustment.

RDC Tyre pressure control
(ReifenDruck-Control)

Equipment

When you ordered your BMW motorcycle, you chose various items of custom equipment. This Rider's Manual describes optional extras (OE) offered by BMW and selected optional accessories (OA). This explains why the manual may also contain descriptions of equipment which you have not ordered. Please note, too, that your motorcycle might not be exactly as illustrated in this manual on account of country-specific differences. If your BMW was supplied with equipment not described in this Rider's Manual, you will

find these features described in separate manuals.

Technical data

All dimensions, weights and power ratings stated in the Rider's Manual are quoted to the standards and comply with the tolerance requirements of the Deutsche Institut für Normung e.V. Versions for individual countries may differ.

Currency

The high safety and quality standards of BMW motorcycles are maintained by constant development work on designs, equipment and accessories. Because of this, your motorcycle may differ from the information supplied in the Rider's Manual. Nor can BMW Motorrad entirely rule out errors and omissions. We hope you will appreciate that no claims can be entertained on

the basis of the data, illustrations or descriptions in this manual.

General views

General view, left side.....	11
General view, right side	13
Underneath the seat	15
Handlebar fitting, left	16
Handlebar fitting, right	17
Instrument cluster	18
Headlight	19



General view, left side

- 1 Windscreen (➡ 63)
- 2 Battery compartment (➡ 134)
- 3 Seat lock (underneath the rear light) (➡ 74)
- 4 Adjuster for spring preload, rear (➡ 68)
- 5 Adjuster for damping characteristic, rear suspension (➡ 69)
- 6 Power socket (➡ 98)



General view, right side

- 1 Fuel filler neck (🔗 87)
- 2 Adjustable handlebars (🔗 67)
- 3 Brake-fluid reservoir, front (🔗 111)
- 4 Adjuster for headlight beam throw (underneath the instrument cluster) (🔗 73)
- 5 Stowage compartment (🔗 66)
- 6 Vehicle identification number

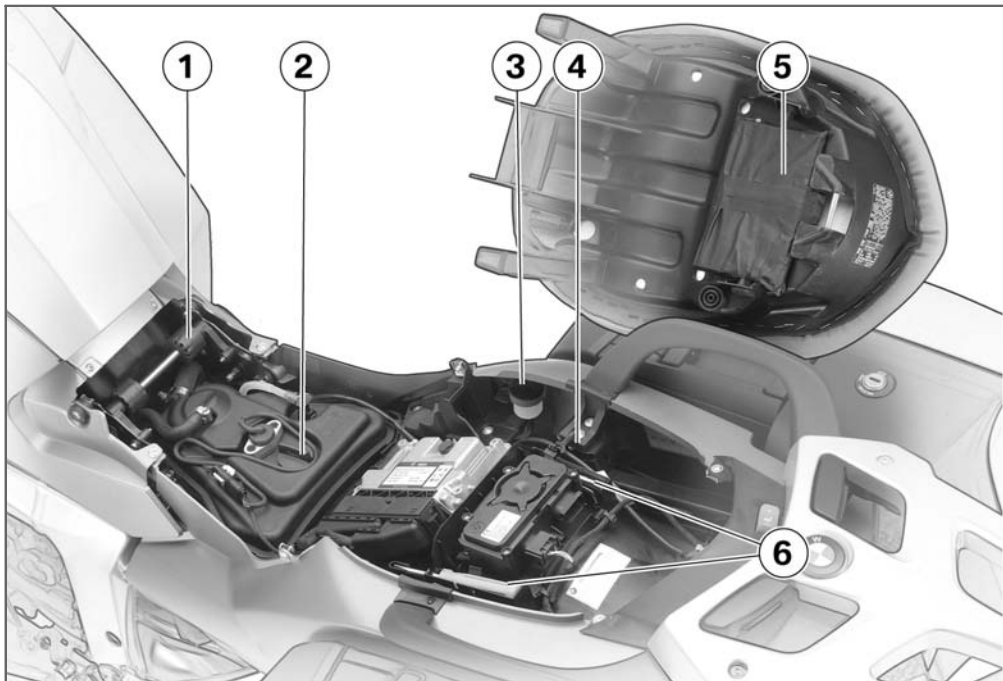

Underneath the seat

- 1 Front-seat height adjustment (➡ 62)
- 2 Oil dipstick (➡ 107),
Engine-oil filler neck
(➡ 109)
- 3 Brake-fluid reservoir, rear
(➡ 112)
- 4 Helmet holder (➡ 76)
- 5 Rider's Manual
- 6 Toolkit (➡ 106)

Handlebar fitting, left

- 1 Cruise-control system^{OE} (→ 63)
- 2 Operating ESA^{OE} (→ 69)
- 3 Operating ASC^{OE} (→ 61)
- 4 Windscreen adjustment (→ 63)
- 5 Horn
- 6 Flashing turn indicators, left (→ 56), Hazard warning flashers (→ 57)
- 7 High-beam headlight and headlight flasher (→ 56)





Handlebar fitting, right

- 1 Operating the on-board computer^{OE} (➔ 51)
- 2 Emergency off switch (kill switch) (➔ 58)
- 3 Starter button (➔ 80)
- 4 Grip heating^{OE} (➔ 59)
- 5 Flashing turn indicators, right (➔ 57), Hazard warning flashers (➔ 57)
- 6 Cancel button, flashing turn indicators (➔ 57), Pushbutton, cancel hazard warning flashers (➔ 58)
- 7 Front-seat heating^{OE} (➔ 60)

Instrument cluster

- 1 Speedometer
- 2 Telltale lights (➔ 22)
- 3 Multifunction display (➔ 22)
- 4 Rev. counter
- 5 Telltale light, anti-theft alarm (OE)
- 6 Set the clock (➔ 49)
Adjust the dimmer (➔ 51)
- 7 Select the odometer (➔ 49)
Reset the tripmeter (➔ 50)
- 8 Sensor for instrument lighting

▶ The instrument-cluster lighting has automatic day and night switchover. ◀

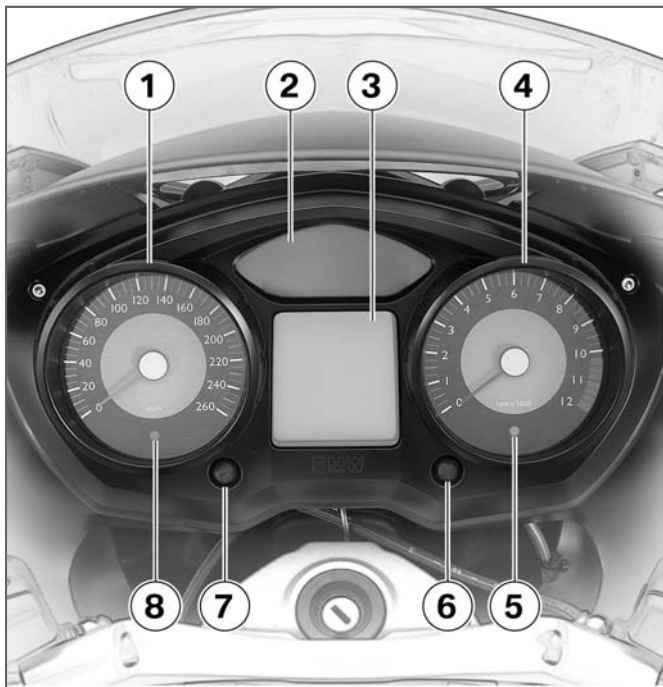

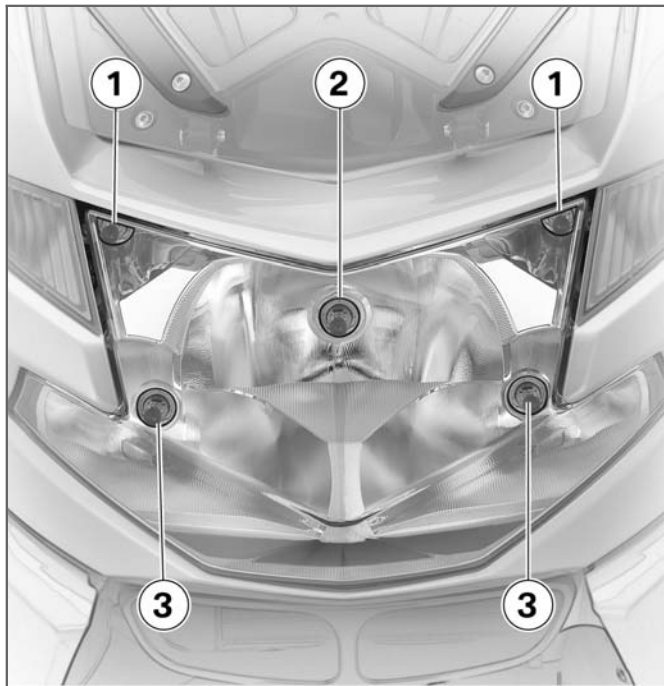

Headlight

- 1 Side lights
- 2 Low-beam headlight
- 3 High-beam headlight

Status indicators

Standard status indicators	22
Status indicators with on-board computer ^{OE}	23
Status indicators with tyre-pressure monitoring (RDC) ^{OE}	24
Status indicators with seat heating ^{OE}	24
Telltale light with cruise control ^{OE}	25
Standard warnings	25
Warnings issued by the on-board computer ^{OE}	30
ABS warnings	32
ASC warnings ^{OE}	34
RDC warnings ^{OE}	36
Anti-theft alarm warnings ^{OE}	41

Standard status indicators

Multifunction display

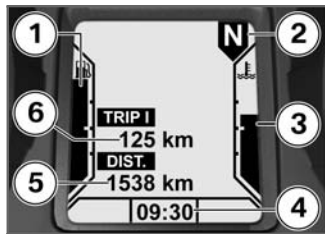

- 1 Fuel capacity (➔ 22)
- 2 Gear indicator (➔ 22)
- 3 Coolant temperature (➔ 22)
- 4 Clock (➔ 49)
- 5 Odometer
- 6 Trip meter (➔ 49)

Telltale lights





- 1 Flashing turn indicators, left
- 2 High-beam headlight
- 3 Idle
- 4 Flashing turn indicators, right

Fuel capacity

 The column below the fuel-pump symbol indicates the remaining quantity of fuel. When the fuel in the tank is topped up the gauge briefly shows the original level, before the reading is updated.

Gear indicator

 The gear engaged or **N** for neutral appears on the display.

 If no gear is engaged, the 'neutral' telltale light also lights up.

Coolant temperature

 The column below the temperature symbol indicates the coolant temperature.

Service-due indicator



If the next service is due in less than one month, the date for

the next service is shown briefly after the Pre-Ride Check completes. The month and year show, accompanied by the word **SERVICE**; in this example the next service is due in March 2007.



If the motorcycle covers long distances in the course of the year, under certain circumstances it might be necessary to have it serviced at a date in advance of the forecast due date. If the countdown distance to the odometer reading at which a service will be due is less than 1000 km,

the distance is counted down in steps of 100 km and is shown briefly after the Pre-Ride Check completes.

If service is overdue, the due date or the odometer reading at which service was due is accompanied by the 'General' warning light showing yellow. The word "Service" remains permanently visible.

▶ If the service-indicator or appears more than a month in advance of the actual due date or if the word "Service" does not show permanently even though a service is overdue, the date stored in memory in the instrument cluster is incorrect and must be set. This situation can occur if the battery was disconnected for a prolonged period of time.

If you want to have the date set consult a specialist workshop,

preferably an authorised BMW Motorrad dealer. ◀

Status indicators with on-board computer^{OE}

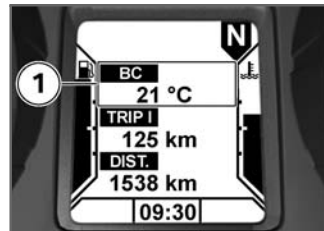

- 1 Status-indicator panel of the on-board computer^{OE} (►► 51)

Status indicators with tyre-pressure monitoring (RDC)^{OE}

Motorcycles without on-board computer



- 1 Tyre pressures as additional readings of the tripmeter^{OE} (→ 54)

Motorcycles with on-board computer

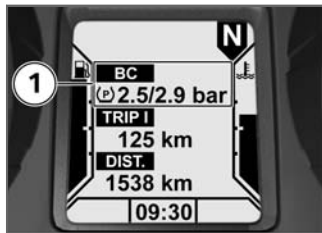

- 1 Tyre pressures as an additional set of readings of the on-board computer^{OE} (→ 54)

Status indicators with seat heating^{OE}



- 1 Indicator for active heating stages^{OE} (→ 60)

Telltale light with cruise control^{OE}

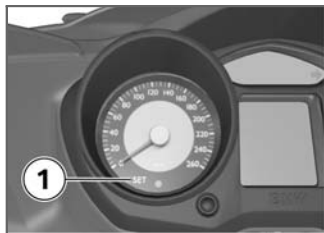

- 1 Telltale light of cruise control

Standard warnings Mode of presentation



















Warnings are indicated by warning light **1** or by 'General' warning light **2** showing in combination with one of the warning symbols **3**. The 'General' warning light shows red or yellow, depending on the urgency of the warning.

If two or more warnings occur at the same time, all the appropriate warning lights and warning symbols appear. The status of the

'General' warning light matches the most urgent warning.

The possible warnings are listed on the next page.

Warnings, overview

		Meaning	
	Lights up yellow	EWS ! appears on the display.	Electronic immobiliser active (➡ 27)
	Lights up yellow	 Flashes	Fuel down to reserve (➡ 27)
	Lights up red	 Temperature reading flashes	Coolant temperature too high (➡ 27)
	Lights up yellow	 Appears on the display	Engine in emergency-operation mode (➡ 27)
	Flashes red	 Appears on the display	Insufficient engine oil pressure (➡ 28)
	Lights up red	 Appears on the display	Insufficient battery charge current (➡ 28)
	Lights up		Brake pads worn down to the wear limit (➡ 29)
	Lights up yellow	 Appears on the display	Rear light bulb defective (➡ 29)
		 Appears on the display	Front light bulb defective (➡ 29)
	Lights up yellow	 Appears on the display	Bulbs defective (➡ 30)

Electronic immobiliser active

 General warning light shows yellow.

EWS ! appears on the display. The key being used is not authorised for starting, or communication between key and engine electronics is disrupted.

- Remove all other vehicle keys from the same ring as the ignition key.
- Use the reserve key.
- Have the defective key replaced, preferably by an authorised BMW Motorrad dealer.

Fuel down to reserve

 General warning light shows yellow.

 Reserve fuel level symbol flashes

 Lack of fuel can result in the engine misfiring and cutting out unexpectedly. Misfiring can damage the catalytic

converter; a hazardous situation can result if the engine cuts out unexpectedly.

Do not run the fuel tank dry.◀

The fuel tank contains no more than the reserve quantity of fuel.

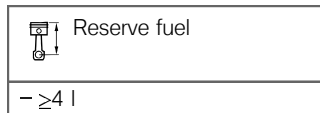

- Refuelling (→ 87)

Coolant temperature too high

 General warning light shows red.

 Temperature reading flashes.

 Continuing to ride when the engine is overheated could result in engine damage.

You must comply with the instructions below.◀

The coolant temperature is too high.

- If possible, ride in the part-load range to cool down the engine.
- In traffic jams, switch off the engine, but leave the ignition switched on so that the radiator or fan continues to operate.
- If the coolant temperature is frequently too high, have the fault rectified as soon as possible by a specialist workshop, preferably an authorised BMW Motorrad dealer.

Engine in emergency-operation mode

 General warning light shows yellow.

 Engine symbol appears on the display.

 The engine is running in emergency operating mode. Engine power might be reduced and this can cause hazardous

situations, particularly if you attempt to overtake other road users.

Engine power level might be lower than normal: adapt your style of riding accordingly.◀

The engine control unit has diagnosed a fault. In exceptional cases, the engine stops and refuses to start. Otherwise, the engine runs in emergency operating mode.

- You can continue to ride, but bear in mind that the usual engine power might not be available.
- Have the fault rectified as quickly as possible by a specialist workshop, preferably an authorised BMW Motorrad dealer.

Insufficient engine oil pressure



General warning light flashes red.



Oil-can symbol appears on the display.

The oil pressure in the lube-oil system is too low. Stop immediately and switch off the engine.



The insufficient oil pressure warning does not fulfil the function of an oil gauge. The only way of checking whether the oil level is correct is to check the oil sight glass.◀

A low oil level is one reason why a warning indicating insufficient oil pressure is issued.

- Check the engine oil level (➡ 107)

If the oil level is too low:

- Top up the engine oil (➡ 109)

If the engine oil level is correct:



Riding when engine-oil pressure is low can result in engine damage.

Do not continue your journey.◀

- Have the fault rectified as quickly as possible by a specialist workshop, preferably an authorised BMW Motorrad dealer.

Insufficient battery charge current



General warning light shows red.



Battery symbol appears on the display.



A discharged battery can cause the engine to die suddenly, and this could result in a dangerous situation in traffic. Have faults rectified as soon as possible.◀

 If the battery is not charging, continuing to ride can cause it to discharge completely, in which case it will suffer irreparable damage.

If possible, do not continue your journey. ◀

Battery is not being charged.

- You can continue to ride until the battery is discharged. Bear in mind, however, that the engine could cut out suddenly and that the battery could discharge until completely flat, in which case it might have suffered irreparable damage.
- Have the fault rectified as quickly as possible by a specialist workshop, preferably an authorised BMW Motorrad dealer.

Brake pads worn down to the wear limit

 Warning light for brake-pad wear shows

The electric brake-pad wear detector has registered that the brake pads of the front or rear brakes have worn down to the acceptable limit.

- Check the front brake pad thickness (➡ 109)
- Check the rear brake pad thickness (➡ 110)
- Have worn brake pads replaced by a specialist workshop, preferably an authorised BMW Motorrad dealer.

Rear light bulb defective

 General warning light shows yellow.

 Bulb symbol with arrow pointing to the rear appears on the display.

 A defective bulb places your safety at risk because it is easier for other users to oversee the motorcycle.

Replace defective bulbs as soon as possible; always carry a complete set of spare bulbs if possible. ◀

Rear light or brake light bulb defective.

- Replacing brake-light, rear light and rear-indicator bulbs (➡ 127)

Front light bulb defective

 Bulb symbol with arrow pointing to the front appears on the display.

 A defective bulb places your safety at risk because it is easier for other users to oversee the motorcycle. Replace defective bulbs as soon as possible; always carry a

complete set of spare bulbs if possible. ◀

Low-beam headlight, high-beam headlight, side-light or turn-indicator bulb defective.

- Replacing low-beam and high-beam headlight bulb (➡ 123)
- Replacing parking-light bulbs (➡ 126)
- Replacing front turn indicator bulbs (➡ 129)

Bulbs defective



General warning light shows yellow.



Bulb symbol with two arrows appears on the display.



A defective bulb places your safety at risk because it is easier for other users to oversee the motorcycle. Replace defective bulbs as soon as possible; always carry a

complete set of spare bulbs if possible. ◀

A combination of the bulb defects described above has occurred.

- See the fault descriptions above.

Warnings issued by the on-board computer^{OE}

Mode of presentation



Warnings issued by the on-board computer appear in panel 1.

The possible warnings are listed on the next page.

Warnings, overview

Meaning

Oil ! appears on the display

Engine-oil level too low ( 32)



Appears on the display

Ambient-temperature reading flashes.

Ice warning ( 32)



Flashes

Engine-oil level too low

Oil ! appears on the display.



Oil-level symbol appears on the display.

The electronic oil-level sensor has registered an excessively low oil level.

Dipping the oil with the dipstick is the only way of ascertaining the exact engine-oil level. The next time you stop for fuel:

- Check the engine oil level (➡ 107)

If the oil level is too low:

- Top up the engine oil (➡ 109)

The oil sensor might be defective if the "Check oil level" message appears even though a check with the dipstick reveals that the oil level is correct.

- Seek the advice of a specialist workshop, preferably an authorised BMW Motorrad dealer.

Ice warning

The ambient-temperature reading flashes.



Ice-crystal symbol flashes.

The air temperature measured at the motorcycle is lower than 3 °C.



The ice warning does not mean that there is no risk of black ice forming at measured temperatures above 3 °C.

Always take extra care and think well ahead when temperatures are low; remember that the danger of black ice is particularly high on bridges and where the road is in the shade.◀

- Ride carefully and think well ahead.

ABS warnings

Mode of presentation



ABS warnings are indicated by ABS warning light **1**.

The way in which the ABS warning light indicates status can differ in some countries.



Possible national variant.

The detailed descriptions relating to BMW Motorrad Integral ABS start on page (➡ 90), and you will find an overview listing the possible warnings on the next page.

Warnings, overview

Meaning

	Flashes	Self-diagnosis not completed (→ 34)
	Lights up	ABS fault (→ 34)

Self-diagnosis not completed



ABS warning light flashes.

The ABS function is not available, because self-diagnosis did not complete. The motorcycle has to move forward a few metres for the wheel sensors to be tested.

- Pull away slowly. Bear in mind that the ABS function is not available until self-diagnosis has completed.

ABS fault



ABS warning light shows.

The ABS control unit has detected a fault. The ABS function is not available.

- You can continue to ride the motorcycle, but make due provision for the fact that the ABS function is not available. Bear in mind the more detailed in-

formation on situations that can lead to an ABS fault (➡ 91).

- Have the fault rectified as quickly as possible by a specialist workshop, preferably an authorised BMW Motorrad dealer.

an overview listing the possible warnings on the next page.

ASC warnings^{OE}





Mode of presentation



ASC warnings are indicated by ASC warning light **1**.

The detailed descriptions relating to BMW Motorrad ASC start on page (➡ 92), and you will find

Warnings, overview

	Meaning
 Quick-flashes	ASC intervention (→ 36)
 Slow-flashes	Self-diagnosis not completed (→ 36)
 Lights up	ASC deactivated (→ 36)
 Lights up	ASC fault (→ 36)

ASC intervention

 ASC warning light quick-flashes.

The ASC has detected a degree of instability at the rear wheel and has intervened to reduce torque. The warning light flashes for longer than ASC intervention lasts. This affords the rider visual feedback on control intervention even after the critical situation has been dealt with.

Self-diagnosis not completed

 ASC warning light slow-flashes.

Self-diagnosis did not complete, so the ASC function is not available. The engine must be running and the motorcycle must reach a speed of at least 5 km/h in order for ASC self-diagnosis to complete.

- Pull away slowly. Bear in mind that the ASC function is not

available until self-diagnosis has completed.

ASC deactivated

 ASC warning light shows.

The rider has switched off the ASC system, with OE Automatic Stability Control (ASC):

- Activate the ASC function (➔ 62)

ASC fault

 ASC warning light shows.

The ASC control unit has detected a fault. The ASC function is not available.

- You can continue to ride. Bear in mind that the ASC function is not available. Bear in mind the more detailed information on situations that can lead to an ASC fault (➔ 93).

- Have the fault rectified as quickly as possible by a specialist workshop, preferably an authorised BMW Motorrad dealer.

RDC warnings^{OE}

Mode of presentation

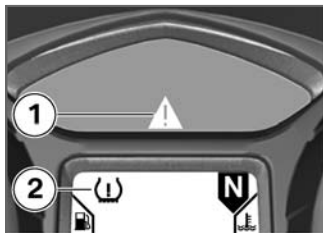

Warning symbol **2** indicates a critical tyre pressure; the corresponding reading flashes. If the critical value is close to the limit of the permissible tolerance range, 'General' warning light **1** shows yellow. If the tyre pressure registered by the sensor is

outside the permissible tolerance range, the 'General' warning light shows red.



The critical tyre press of the front wheel **3** or as applicable the rear wheel **4** flashes.



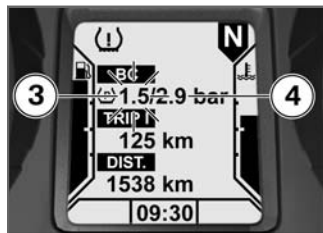





with OE On-board computer:



The critical tyre press of the front wheel **3** or as applicable the rear wheel **4** flashes.◀

The detailed descriptions relating to BMW Motorrad RDC start on page (➔ 94), and you will find an overview listing the possible warnings on the next page.

Warnings, overview

		Meaning	
	Lights up yellow		Appears on the display Tyre pressure close to limit of permitted tolerance (➡ 39) The critical tyre pressure flashes
	Flashes red		Appears on the display Tyre pressure outside permitted tolerance (➡ 39) The critical tyre pressure flashes
			"--" or "-- --" appears on the display Signal transmission disrupted (➡ 39)
	Lights up yellow		Appears on the display Sensor defective or system error (➡ 40) "--" or "-- --" appears on the display
	Lights up yellow		RDC appears on the display Tyre-pressure sensor battery weak (➡ 40)
			Appears on the display

Tyre pressure close to limit of permitted tolerance



General warning light shows yellow.



Tyre symbol appears on the display.

The critical tyre pressure flashes. Measured tyre pressure is close to the limit of permitted tolerance.

- Correct the tyre pressure as stated on the inside cover of the Rider's Manual.



The tyre-pressures listed on the inside cover are temperature-compensated; the reference tyre temperature for these readings is always 20 °C. The procedure for correcting tyre pressures when the tyres are not at this reference temperature is as follows:

Calculate the difference between the specified value stated in the Rider's Manual and the reading

shown by the RDC system. Use the public air line at a petrol station or motorway service area to adjust the tyre pressure by this amount. ◀

Tyre pressure outside permitted tolerance



General warning light flashes red.



Tyre symbol appears on the display.

The critical tyre pressure flashes. Measured tyre pressure is outside permitted tolerance.

- Check the tyre for damage and to ascertain whether the motorcycle can be ridden with the tyre in its present condition.

If the motorcycle can be ridden with the tyre in its present condition:



Incorrect tyre pressures impair the motorcycle's handling characteristics.

If tyre pressure is incorrect it is essential to adapt your style of riding accordingly. ◀

- Correct the tyre pressure at the earliest possible opportunity.
- Have the tyre checked for damage by a specialist workshop, preferably an authorised BMW Motorrad dealer.

If you are unsure whether the motorcycle can be ridden with the tyre in its present condition:

- Do not continue your journey.
- Notify the breakdown service.
- Have the tyre checked for damage by a specialist workshop, preferably an authorised BMW Motorrad dealer.

Signal transmission disrupted

"--" or "-- --" appears on the display.

The motorcycle has not yet accelerated past the threshold of approximately 30 km/h. The RDC sensors do not start transmitting signals until the motorcycle reaches a speed above this threshold (➡ 94).

- Increase speed above this threshold and observe the RDC readings. Assume that a permanent fault has not occurred unless the 'General' warning light comes on to accompany the symptoms. Under these circumstances:
- Have the fault rectified by a specialist workshop, preferably an authorised BMW Motorrad dealer.

Wireless communication with the RDC sensors has been disrupted. Possible causes include radio-communication systems operating in the vicinity and interfering

with the link between the RDC control unit and the sensors.

- Move to another location and observe the RDC readings. Assume that a permanent fault has not occurred unless the 'General' warning light comes on to accompany the symptoms. Under these circumstances:
- Have the fault rectified by a specialist workshop, preferably an authorised BMW Motorrad dealer.

Sensor defective or system error



General warning light shows yellow.



Tyre symbol appears on the display.

"---" or "--- ---" appears on the display.

Motorcycle is fitted with wheels not equipped with RDC sensors.

- Fit wheels and tyres equipped with RDC sensors.

One or two RDC sensors have failed.

- Have the fault rectified by a specialist workshop, preferably an authorised BMW Motorrad dealer.

A system error has occurred.

- Have the fault rectified by a specialist workshop, preferably an authorised BMW Motorrad dealer.

Tyre-pressure sensor battery weak



General warning light shows yellow.

RDC appears on the display.



Battery symbol appears on the display.

▶ This error message appears only briefly after the pre-ride check completes. ◀

The integral battery in the tyre-pressure sensor has lost a significant proportion of its original capacity. There is no assurance of how long the tyre pressure control system can remain operational.

- Seek the advice of a specialist workshop, preferably an authorised BMW Motorrad dealer.

Anti-theft alarm warnings^{OE}

Mode of presentation







Anti-theft alarm warnings appear in panel **2** in combination with the 'General' warning light **1** showing after the Pre-Ride Check and relate to the capacity of the internal battery that supplies power to the anti-theft alarm.

The possible warnings are listed on the next page.

Warnings, overview

Meaning

		Appears on the display	Anti-theft alarm battery weak ( 43)	
	Lights up yellow		Appears on the display	Anti-theft alarm battery flat ( 43)

Anti-theft alarm battery weak



Battery symbol appears on the display.

DWA appears on the display.



This error message appears only briefly after the pre-ride check completes.◀

The integral battery in the anti-theft alarm has lost a significant proportion of its original capacity. There is no assurance of how long the anti-theft alarm can remain operational if the motorcycle's battery is disconnected.

- Seek the advice of a specialist workshop, preferably an authorised BMW Motorrad dealer.

Anti-theft alarm battery flat



General warning light shows yellow.



Battery symbol appears on the display.

DWA appears on the display.



This error message appears only briefly after the pre-ride check completes.◀

The integral battery in the anti-theft alarm has lost its entire original capacity. There is no assurance that the anti-theft alarm will be operational if the motorcycle's battery is disconnected.

- Seek the advice of a specialist workshop, preferably an authorised BMW Motorrad dealer.

Operation

Ignition switch and steering lock	47	Automatic Stability Control ASC ^{OE}	61
Electronic immobiliser	48	Seat height	62
Clock	49	Windscreen	63
Odometer and tripmeters	49	Cruise-control system ^{OE}	63
Multifunction display	51	Stowage compartment	66
On-board computer ^{OE}	51	Clutch	66
Tyre pressure monitoring RDC ^{OE}	54	Brakes	67
Lights	55	Handlebars	67
Turn indicators	56	Mirrors	68
Hazard warning flashers	57	Spring preload	68
Emergency off switch (kill switch)	58	Damping	69
Grip heating ^{OE}	59	Electronic Suspension Adjustment ESA ^{OE}	69
Seat heating ^{OE}	60	Tyres	72

Headlight 72
Front and rear seats 73
Helmet holder 76

Ignition switch and steering lock

Keys

You receive one master key and one spare key. Please consult the information on the electronic immobiliser (EWS) if a key is lost or mislaid (➡ 48).

Ignition switch and steering lock, tank filler cap lock and the seat and case locks are all operated with the same key.

with OA Topcase:

If you wish you can arrange to have the topcase fitted with a lock that can be opened with this key as well. Consult a specialist workshop, preferably an authorised BMW Motorrad dealer.◁

Switching on ignition

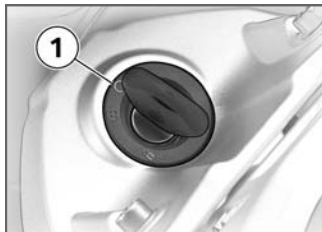

- Turn the key to position **1**.
 - » Side light and all function circuits switched on.
 - » Engine can be started.
 - » Pre-ride check is performed. (➡ 81)
 - » ABS self-diagnosis is performed. (➡ 82)

with OE ASC:

- Turn the key to position **1**.
 - » ASC self-diagnosis is performed in addition to the checks outlined above. (➡ 82)◁

Switching off ignition



- Turn the key to position **2**.
 - » Lights switched off.
 - » Handlebars not locked.
 - » Key can be removed.
 - » Electrically powered accessories remain operational for a limited period of time.
 - » The battery can be recharged via the on-board socket.

Locking handlebars



! If the motorcycle is on the side stand, the surface of the ground will determine whether it is better to turn the handlebars to the left or right. However, the motorcycle is more stable on a level surface with the handlebars turned to the left than with the handlebars turned to the right.

On level ground, always turn the handlebars to the left to set the steering lock. ◀

- Turn the handlebars to the full left or right lock position.

- Turn the key to position **3**, while moving the handlebars slightly.
- » Ignition, lights and all function circuits switched off.
- » Handlebars locked.
- » Key can be removed.

Electronic immobiliser Protection against theft

The electronic immobiliser helps protect your BMW motorcycle from theft, and this enhanced security is at your disposal without any need for you to set parameters or activate additional systems. The engine of a motorcycle fitted with this electronic immobiliser can be started only with the keys that belong to the vehicle. You can also have your authorised BMW Motorrad dealer bar individual keys, for example if a particular key goes missing. The

engine cannot be started with a key that has been barred.

In-key electronics

The motorcycle's electronics exchange certain continuously changing signals with the electronics in the key; these signals are specific to your motorcycle and they are transmitted via the ring aerial in the ignition lock. The ignition is not enabled for starting until the key has been recognised as "authorised" for your motorcycle.

▶ A spare key attached to the same ring as the ignition key used to start the engine could "irritate" the electronics, in which case the enabling signal for starting is not issued. The **EWS** warning appears in the multifunction display. Always keep the spare key separately from the ignition key. ◀

Replacement and extra keys

You can obtain replacement/extra keys only through an authorised BMW Motorrad dealer. The keys are part of an integrated security system, so the dealer is under an obligation to check the legitimacy of all applications for replacement/extra keys. If you want to have a lost key barred, you have to bring with you all the other keys that belong to the motorcycle. A key that has been barred can subsequently be cleared and reactivated for use.

Clock

Setting clock

 Attempting to set the clock while riding the motorcycle can lead to accidents. Set the clock only when the motorcycle is stationary. ◀

- Switch on the ignition.



- Press and hold down button **1**.
 - » Hours reading **2** flashes.
- Press button **1**.
 - » The hours reading increments by one each time you press the button.
- Press and hold down button **1**.
 - » Minutes reading **3** flashes.
- Press button **1**.
 - » The minutes reading increments by one each time you press the button.

- Either press and hold down button **1** or wait without pressing a button.
 - » The clock is now set and the time appears on the display.

Odometer and tripmeters

Selecting odometer

- Switch on the ignition.



- Press button **1**.



The display starts with the current value and each time the button is pressed it moves one step through the following sequence:

- Tripmeter 1 (Trip I)
- Tripmeter 2 (Trip II)
- Residual range (once fuel level is down to reserve)
- Tyre pressures (OE)

The total distance appears in the DIST line of the display.

Resetting tripmeter

- Switch on the ignition.
- Select the desired tripmeter.



- Press and hold down button **1**.
» The tripmeter is reset to zero.

Residual range



Residual-range reading **1** appears below the word RANGE and indicates how far you can ride with

the fuel remaining in the tank. This reading is not displayed until fuel level has dropped to reserve. This distance is calculated on the basis of fuel level and average consumption.

When you refuel, the increase in fuel level is not registered unless several litres are added to the fuel already in the tank.

When refuelling after running on reserve, make sure that you top up the tank to a level above reserve, as otherwise the sensor will not be able to register the new level. If the sensor cannot register the new level neither the fuel-level reading nor the residual-range readout can be updated.

▶ The calculated range is an approximate value. Consequently, BMW Motorrad recommends that you should not try to use the full residual range before refuelling.◀

Multifunction display Adjusting dimmer



 Attempting to adjust the dimmer while riding the motorcycle can lead to accidents. Do not attempt to adjust the dimmer unless the motorcycle is at a standstill. ◀

- Press button **1**.
 - » The level of dimming appears in display field **2**.
- Press button **1** again.
 - » The brightness of the display increases one level each time you press the button.

Each time you press the button after maximum brightness is reached, brightness is reduced by one level.

On-board computer^{OE} Selecting readings

- Switch on the ignition.



- Press button **1**.



The display starts with the current value and each time the button is pressed it moves one step through the following sequence:

- Ambient temperature
- Range
- Average speed
- Average consumption
- Oil level
- Tyre pressures (OE)

Ambient temperature



When the motorcycle is at a standstill the heat of the engine can falsify ambient-temperature reading **1**. If the effect of the engine's heat becomes excessive, – – temporarily appears on the display.

 If ambient temperature drops below 3 °C a warning appears, drawing your attention to the risk of black ice forming. The display automatically switches from any other mode to the temperature reading when

the temperature drops below this threshold for the first time.

Range



The description of the residual-range function (→ 50) also covers the range readout. You can also view range **1** before the fuel level drops to reserve. A special average-consumption figure is used to calculate range; this figure is not necessarily the same as the value you can call up for viewing on the display.

When the motorcycle is propped on its side stand the slight angle of inclination means that the

sensor cannot register the fuel level correctly. This is the reason why the range is calculated only when the motorcycle is on the move.

When refuelling after running on reserve, make sure that you top up the tank to a level above reserve, as otherwise the sensor will not be able to register the new level. If the sensor cannot register the new level neither the fuel-level reading nor the range readout can be updated.

 The calculated range is only an approximate reading. Consequently, BMW Motorrad recommends that you should not try to use the full range before refuelling.◀

Average speed



Average speed **1** is calculated on the basis of the time elapsed since the last reset. Times during which the engine was stopped are excluded from the calculation.

Resetting average speed

- Switch on the ignition.
- Select average speed.



- Press and hold down button **1**.
» Average speed is reset to zero.

Average consumption



Average consumption **1** is calculated by dividing the distance covered since the last reset by

the corresponding amount of fuel used.

Resetting average consumption

- Switch on the ignition.
- Select average consumption.



- Press and hold down button **1**.
» Average consumption is reset to zero.

Oil level





Oil-level indicator **1** gives you an indication of the engine oil level. You can call up this reading only when the motorcycle is at a standstill.

The preconditions for the oil level check are as follows:

- Engine at operating temperature.
- Engine idling for at least 30 seconds.
- Side stand retracted.
- Make sure the motorcycle is upright.

The readings mean:

 Oil level is correct

 Check the oil level with the dipstick the next time you stop for fuel. If you call up another reading on the on-board computer, this symbol remains visible until the sensor again registers a correct oil level.

 Oil level cannot be measured (conditions as stated above not satisfied).

The most recently measured level is displayed for 5 seconds when you next switch on the ignition.

 The oil sensor might be defective if the "Check oil level" message reappears even though the oil level in the oil sight glass is correct. In this case, consult your authorised BMW Motorrad dealer. ◀

Tyre pressure monitoring RDC^{OE}

Viewing tyre-pressure readings

- Switch on the ignition.



- Repeatedly press button **1** until the tyre pressures appear in the odometer panel of the display.



The tyre pressures are shown, accompanied by the wording RDC. The front tyre pressure is on the left; the reading on the right is the rear tyre pressure. -- -- appears directly after the ignition is switched on, because the sensors do not transmit tyre pressures until the motorcycle accelerates to 30 km/h.

 Indicates the reading for tyre pressures.

with OE On-board computer:



- Repeatedly press button **1** until the tyre pressures appear in the on-board computer panel of the display.

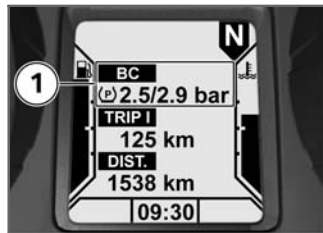

The tyre pressures are displayed as an additional set of readings by the on-board computer.◀

Lights

Side light

The side lights switch on automatically when the ignition is switched on.

 The side lights place a strain on the battery. Do not switch the ignition on for longer than absolutely necessary.◀

Low-beam headlight

The low-beam headlight switches on automatically when you start the engine.

▶ When the engine is not running you can switch on the lights by switching on the ignition and either switching on the high-beam headlight or operating the headlight flasher.◀

High-beam headlight



- Press the top section of full-beam headlight switch **1**.
- » High-beam headlight switched on.

- Move full-beam headlight switch **1** to the centre position.
- » High-beam headlight switched off.
- Press the bottom section of full-beam headlight switch **1**.
- » The high-beam headlight is switched on until you release the button (headlight flasher).

Switching on parking lights

- Switch off the ignition.



- Immediately after switching off the ignition, press and hold

down button **1** for the left turn indicators.

» Parking light switches on.

Switching off parking lights

- Switch the ignition on and then off again.
- » Parking lights switched off.

Turn indicators

Switching on left flashing turn indicators

- Switch on the ignition.

▶ The turn indicators are cancelled automatically after you have ridden for approximately 10 seconds, or covered a distance of about 200 m.◀



- Press button **1** for the left-hand turn indicators.
 - » Left-hand turn indicators switched on.
 - » Telltale light for left-hand turn indicators flashes.

Switching on right flashing turn indicators

- Switch on the ignition.

▶ The turn indicators are cancelled automatically after you have ridden for approximately 10 seconds, or covered a distance of about 200 m.◀



- Press button **2** for the right-hand turn indicators.
 - » Right-hand turn indicators switched on.
 - » Telltale light for right-hand turn indicator flashes.

Cancelling turn indicators



- Press cancel button **3**.
 - » Flashing turn indicators switched off.
 - » Turn indicator telltale light is off.

Hazard warning flashers

Switching on hazard warning flashers

- Switch on the ignition.

▶ The hazard warning flashers place a strain on the battery. Do not use the hazard

warning flashers for longer than absolutely necessary. ◀

▶ If you press a turn-indicator button with the ignition switched on, the turn-indicator function is activated instead of the hazard warning flashers, and remains active until you release the button. The hazard warning flashers recommence flashing as soon as the button is released. ◀

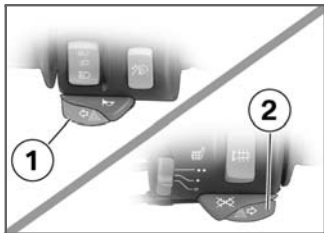

- Simultaneously press button **1** for left turn indicators and button **2** for right turn indicators.

- » The hazard warning flashers are switched on.
- » Left/right turn indicator telltale lights flash.
- Switch off the ignition.
- » The hazard warning flashers continue to operate.
- » Left/right turn indicator telltale lights off.

Switching off hazard warning flashers



- Press cancel button **3**.
- » Hazard warning flashers switched off.

Emergency off switch (kill switch)



- 1** Emergency off switch (kill switch)

⚠ Operating the kill switch when riding can cause the rear wheel to lock and thus cause a fall. Do not operate the kill switch when riding. ◀

The emergency off switch is a kill switch for switching off the engine quickly and easily.

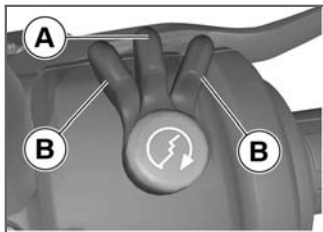

A Normal operating position (run)

B Engine switched off.

▶ You cannot start the engine unless the kill switch is in the run position.◀

Grip heating^{OE}



1 Grip heating switch

The handlebar grips have two-stage heating. Grip heating can be activated only when the engine is running.

▶ The increase in power consumption caused by the grip heating can drain the battery if you are riding at low engine speeds. If the charge level is low, grip heating is switched off to ensure the battery's starting capability.◀

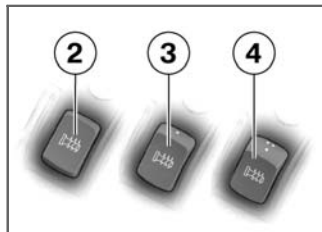

2 Heating off.

3 50 % heat output (one dot visible)

4 100 % heat output (three dots visible)

Seat heating ^{OE}

Seat heating, front seat



- 1** Switch for seat heating, front seat

The front seat has two-stage heating. Seat heating can be activated only when the engine is running.

▶ The increase in power consumption caused by the seat heating can drain the battery if you are riding at low engine speeds. If the charge level is low, seat heating is switched

off to ensure the battery's starting capability. ◀



- 2** Heating off.
3 50% heating power
4 100% heating power

Seat heating, rear seat

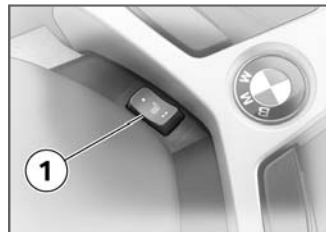

- 1** Switch for seat heating, rear seat

The rear seat has two-stage heating. Seat heating can be activated only when the engine is running.

▶ The increase in power consumption caused by the seat heating can drain the battery if you are riding at low engine speeds. If the charge level is low, seat heating is switched off to ensure the battery's starting capability. ◀

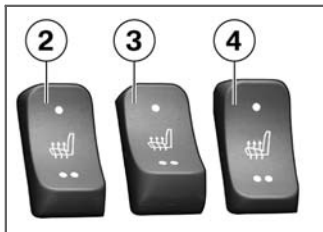





- 2 Switch centred: Heating off.
- 3 Switch pushed to right: 50% heat output.
- 4 Switch pushed to left: 100% heat output.

Indicator in multifunction display

- Switch on the front-seat or rear-seat heating.



The symbols shown below appear on the display to indicate which heating stage has been selected:

-  Front seat, 50 % heating power
-  Front seat, 100 % heating power
-  Rear seat, 50 % heating power
-  Rear seat, 100 % heating power

Automatic Stability Control ASC^{OE}

Deactivating ASC function

- Switch on the ignition.

 You have the option of deactivating the ASC function while the motorcycle is on the move. ◀



- Press and hold down ASC button **1**.

 ASC warning light starts to show.

- When the ASC symbol appears, release the ASC button within three seconds.

 ASC warning light remains ON.

» The ASC function is deactivated.

Activating ASC function



- Press and hold down ASC button **1**.

 ASC warning light goes out; if self-diagnosis has not completed the ASC warning light starts flashing.

- When the ASC symbol disappears, release the ASC button within three seconds.

 The ASC warning light remains off or continues to flash.

- » The ASC function is activated.
- Instead of pressing the ASC button, you have the option of switching the ignition off and then on again.

 An ASC fault has occurred if the ASC warning light shows when the motorcycle accelerates to a speed in excess of 10 km/h after the ignition was switched off and then on again.◀

Seat height Adjusting seat height

- Remove the front seat (➔ 74)

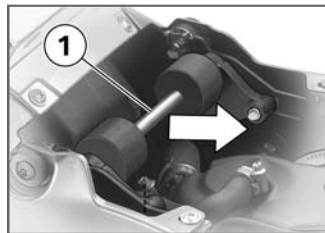

- Pull seat-height adjuster **1** to the limit position.

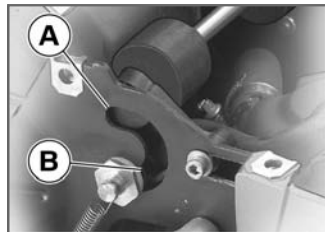

- Push the seat height adjuster fully forward and up or down, as applicable.

- » Limit position **A**: high seat position.
- » Limit position **B**: low seat position.
- Install the front seat (🔗 75)

Windscreen

Adjusting windscreen

- Switch on the ignition.



- Press the top section of button **1**.
- » Windscreen higher
- Press the bottom section of button **1**.
- » Windscreen lower

Cruise-control system^{OE}

Switching on cruise control

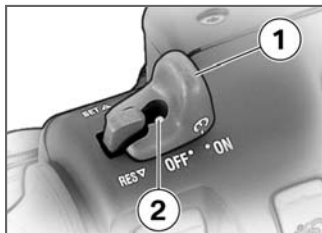

- Move switch **1** to ON.
- » Telltale light **2** in the switch lights up red.

Setting road speed

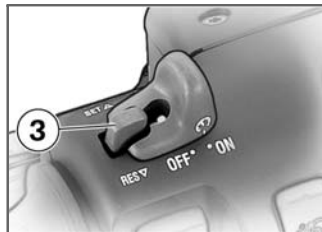

- Briefly push button **3** in the SET direction

▶ Cruise control can be used in the speed range from 50 km/h to 180 km/h.◀

SET Telltale light for cruise control shows.

- » The motorcycle maintains your current cruising speed and the setting is saved.

Step-by-step acceleration

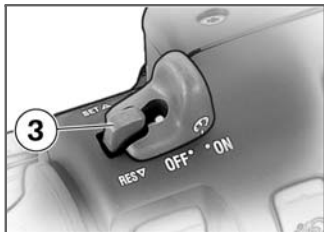

- Briefly push button **3** in the SET direction
- » Speed is increased by approx. 2 km/h each time you push the button, and the new setting is saved.

Stepless acceleration

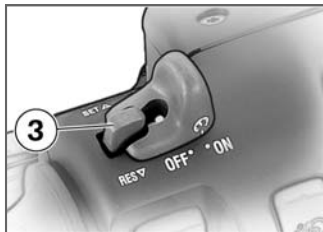

- Push button **3** in the SET direction and hold it in this position.
- » The motorcycle accelerates steplessly.
- Release button **3**.
- » The motorcycle maintains your current cruising speed and the setting is saved.

Step-by-step deceleration



- Briefly push button **3** in the RES direction
- » Speed is decreased by approx. 2 km/h each time you push the button, and the new setting is saved.
- Release button **3**.
- » The motorcycle maintains your current cruising speed and the setting is saved.

Stepless deceleration

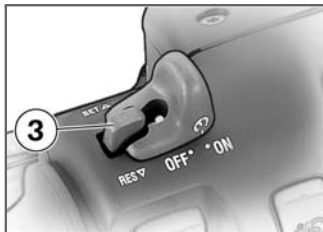

- Push button **3** in the RES direction and hold it in this position.
 - » The motorcycle decelerates steplessly.
- Release button **3**.
 - » The motorcycle maintains your current cruising speed and the setting is saved.

Deactivating cruise control

- Apply the brakes or pull the clutch or close the throttle (turn

the throttle twistgrip back past the idle position).

- » The cruise-control system is deactivated.
- » The cruise control telltale light goes out.
- » The telltale light in the switch remains on.

Resuming former cruising speed

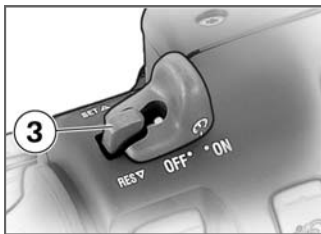

- Push button **3** in the RES direction.

 Opening the throttle does not deactivate the cruise-control system. If you release

the twistgrip the motorcycle will decelerate only to the cruising speed saved in memory, even though you might have intended slowing to a lower speed. ◀

SET Telltale light for cruise control shows.

- » The motorcycle resumes the previous cruising speed.

Switching off cruise control

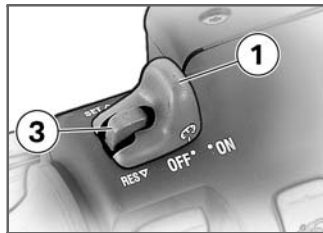

- Move switch **1** to OFF.
 - » The system is deactivated.
 - » Button **3** is locked.

Stowage compartment

Opening stowage compartment

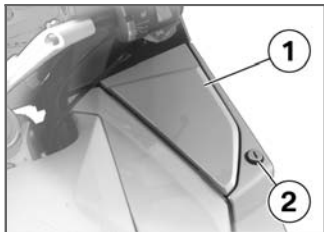

- Use the ignition key to turn lock barrel **2** to right angles with the forward direction of travel.
- » Lock of the stowage compartment unlocked.
- Push the lock barrel in.
- » Lid **1** pops up.

Closing stowage compartment

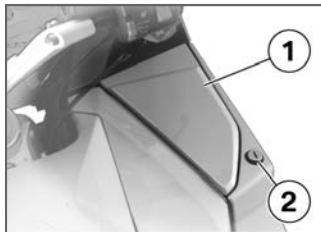

- Snap lid **1** closed and push it down.
- » The lock engages with an audible click.
- Use the ignition key to turn lock barrel **2** in line with the forward direction of travel.
- » Lock of the stowage compartment locked.

Clutch

Adjusting clutch lever

⚠ If the position of the clutch fluid reservoir is changed, air can enter the clutch system. Do not twist the handlebar fitting or the handlebars. ◀

⚠ Attempting to adjust the clutch lever while riding the motorcycle can lead to accidents. Do not attempt to adjust the clutch lever unless the motorcycle is at a standstill. ◀

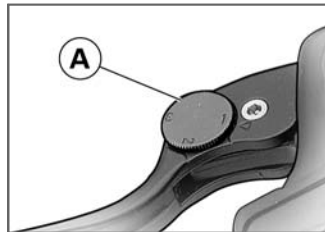

- Turn adjuster **A** to position **1**:

▶ The adjuster is easier to turn if you push the clutch lever forward.◀

» Smallest span.

• Turn adjuster **A** to position **3**:

» Largest span.

Brakes

Adjusting handbrake lever

 Changing the position of the brake-fluid reservoir can allow air to penetrate the brake system.

Do not twist the handlebar fitting or the handlebars.◀

 Attempting to adjust the brake lever while riding the motorcycle can lead to accidents. Do not attempt to adjust the brake lever unless the motorcycle is at a standstill.◀

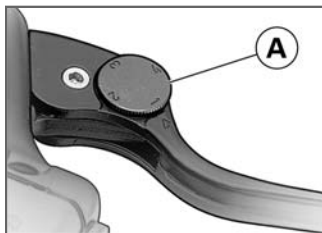

• Turn adjuster **A** to position **1**:

▶ The adjuster is easier to turn if you push the brake lever forward.◀

» Smallest span.

• Turn adjuster **A** to position **3**:

» Largest span.

Handlebars

Adjustable handlebars

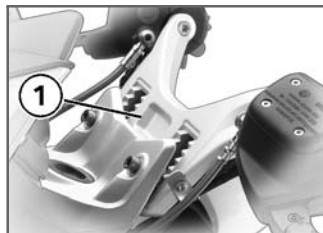

Handlebars **1** are height-adjustable. If you want to have the handlebars adjusted consult a specialist workshop, preferably an authorised BMW Motorrad dealer.

Mirrors

Adjusting mirrors

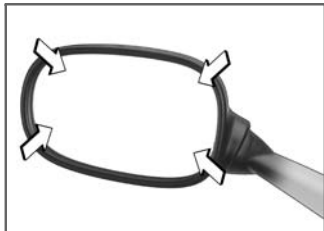

- Turn the mirror to the correct position.

Spring preload Setting

It is essential to set spring preload of the rear suspension to suit the load carried by the motorcycle. Increase spring preload when the motorcycle is heavily loaded and reduce spring preload accordingly when the motorcycle is lightly loaded.

Adjusting spring preload for rear wheel

- Make sure the ground is level and firm and place the motorcycle on its stand.

 The knob can be pulled out and angled down for easier accessibility. ◀



 Your motorcycle's handling will suffer if you do not match the spring-preload and damping-characteristic settings. Adjust the damping characteristic to suit spring preload. ◀

 Adjusting spring preload while the motorcycle is being ridden can lead to accidents. Do not attempt to adjust spring preload unless the motorcycle is at a standstill. ◀

- If you want to increase spring preload, turn knob **1** in the direction indicated by the HIGH arrow.
- If you want to reduce spring preload, turn knob **1** in the direction indicated by the LOW arrow.

 Basic setting of spring preload, rear

- Turn the knob as far as it will go in the direction indicated by the LOW arrow and then turn it back 15 clicks in the direction indicated by the HIGH arrow. (Full load of fuel, with rider 85 kg)

Damping Setting

Damping must be adapted to suit spring preload. An increase in spring preload requires firmer damping, a reduction in spring preload requires softer damping.

Adjusting damping for rear wheel

- Make sure the ground is level and firm and place the motorcycle on its stand.

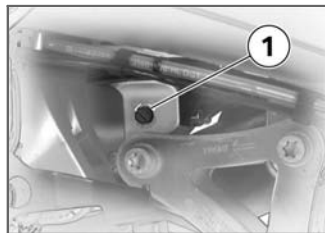

- Adjust the rear shock absorber, using the tool from the on-

board toolkit to turn adjusting screw **1**.

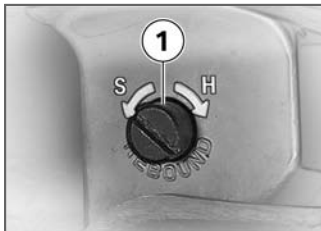

- If you want a harder damping characteristic, use a screwdriver to turn adjusting screw **1** in the direction indicated by the H arrow.
- If you want a softer damping characteristic, use a screwdriver to turn adjusting screw **1** in the direction indicated by the S arrow.

 Basic setting of rear-suspension damping characteristic

- Turn the adjusting screw as far as it will go in the direction indicated by the H arrow and then turn it back one and a half turns in the direction indicated by the S arrow. (One-up 85 kg)

Electronic Suspension Adjustment ESA^{OE} Settings

Electronic Suspension Adjustment ESA provides a convenient way of adapting the motorcycle to the load it carries and the surface over which you intend riding.



The damping characteristic is shown in panel **1** of the multi-function display, and spring preload in panel **2**. The clock is not shown while the ESA readout is active. Three spring preload settings can each be combined with three damping characteristics to fine-tune the motorcycle's suspension.

Adjuster, spring preload

The ESA control unit is protected by an overload cutout designed to stop the spring-preload adjustment process if current consumption reaches an unaccept-

ably high level. Please note that a combination of low ambient temperature and a high payload tends to increase the possibility of elevated current consumption, and under these circumstances adjustment might be interrupted by the overload cutout.

If the motorcycle is to be used for two-up riding and ambient temperature is below 0 °C, BMW Motorrad recommends adjusting the suspension to the setting for two-up riding and allowing adjustment to complete before your passenger mounts the motorcycle. Similarly, BMW Motorrad recommends relieving the weight on the motorcycle when you are going to adjust over a long range of travel (adjusting from "one-up" to "two-up with luggage").

The ESA indicator continues to flash until adjustment completes. If adjustment is interrupted the process resumes as soon as

current consumption drops below the defined threshold, for example when the above-mentioned measures are adopted.

Calling up settings

- Switch on the ignition.



- Press button **1**.
 - » The current setting is displayed.
 - » The reading remains visible for a few seconds before disappearing automatically.

Adjusting suspension damping

- Switch on the ignition.

▶ You can adjust the damping characteristic while the motorcycle is on the move.◀



- Press button **1**.
- » The current setting is displayed.
- Press button **1** once at each step.

The display field starts at the current status and cycles through the following sequence:



- COMF Comfortable damping characteristic
 - NORM Normal damping characteristic
 - SPORT Sporty damping characteristic
- » The setting shown on the display is automatically accepted as the damping characteristic if you allow a certain length of time to pass without pressing button **1**.

Adjusting spring preload

- Start the engine.

▶ You cannot adjust spring preload while the motorcycle is on the move.◀



- Press button **1**.
 - » The current setting is displayed.
 - Press and hold down button **1** until the reading changes.
- The display field starts at the current status and cycles through the following sequence:
-  One-up
 -  One-up with luggage
 -  Two-up (with luggage)

- The setting shown on the display is automatically accepted as the spring preload if you allow a certain length of time to pass without pressing button **1**. The reading flashes while adjustment is in progress.

Tyres

Checking tyre pressure

- Make sure the ground is level and firm and place the motorcycle on its stand.

 Incorrect tyre pressures impair the motorcycle's handling characteristics and increase the rate of tyre wear.



Always check that the tyre pressures are correct. ◀

 At high road speeds, tyre valves have a tendency to open as a result of centrifugal force.

Fit metal valve caps with rubber

seals and screw them on firmly to prevent sudden deflation. ◀

- Check that tyre pressures are correct as per the data below.

	Tyre pressure, front
	– 2.5 bar (one-up, tyre cold)
	– 2.5 bar (two-up and/or with luggage, tyre cold)
	Tyre pressure, rear
	– 2.9 bar (one-up, tyre cold)
	– 2.9 bar (two-up and/or with luggage, tyre cold)

If tyre pressure is too low:

- Correct the tyre pressures.

Headlight

Adjusting headlight for driving on left/driving on right

If the motorcycle is ridden in a country where the opposite rule of the road applies, its asymmetric low-beam headlight will tend to dazzle oncoming traffic. Have the headlight set accordingly by a specialist workshop, preferably an authorised BMW Motorrad dealer.

 Commercially available adhesive tape will damage the plastic lens of the light.

Consult a specialist workshop, preferably an authorised BMW Motorrad dealer, in order to avoid damaging the plastic lens of the light. ◀

Headlight beam throw and spring preload

Headlight beam throw is generally kept constant when spring preload is adjusted to suit load. Spring preload adjustment might not suffice only if the motorcycle is very heavily loaded. Under these circumstances, headlight beam throw has to be adjusted to suit the weight carried by the motorcycle.

▶ Consult a specialist workshop, preferably an authorised BMW Motorrad dealer, if you are unsure whether the headlight basic setting is correct. ◀

Headlight beam-throw adjustment

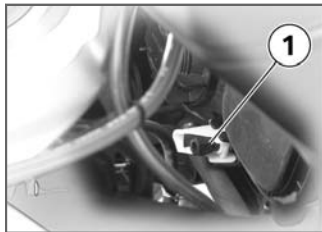

1 Headlight beam-throw adjustment

Spring preload adjustment might not suffice if the motorcycle is very heavily loaded. Moving the pivot lever adjusts headlight beam throw so as not to dazzle oncoming traffic.

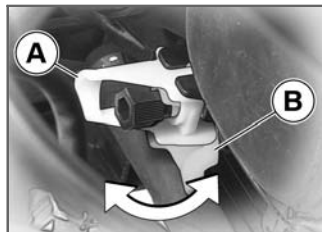

- A Neutral position
- B Position for heavy load

Front and rear seats

Removing rear seat

- Make sure the ground is level and firm and place the motorcycle on its stand.

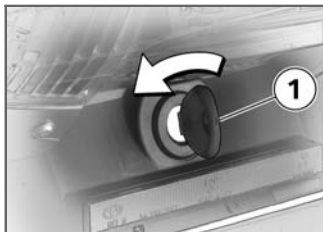

- Turn key **1** counter-clockwise in the seat lock.

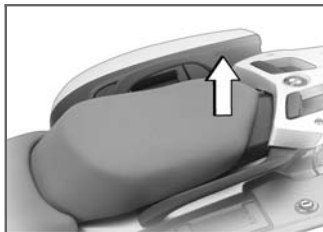

- Lift the seat at the rear and release the key.

with OE Seat heating:

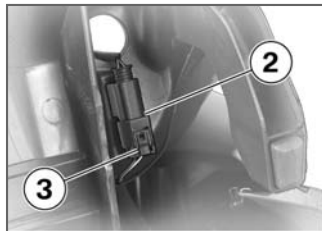

- Disconnect plug **2** by squeezing locking tabs **3** together at top and bottom.<
- Pull the seat to the rear to release it from its holders.
- Place the seat, upholstered side down, on a clean surface.

Removing front seat

- Remove the rear seat (➡ 73)

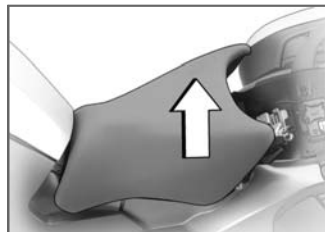

- Lift the rear of the front seat.

with OE Seat heating:

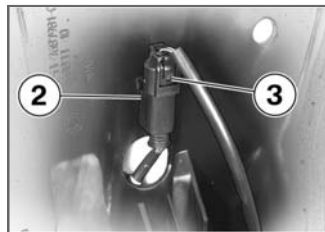

- Disconnect plug **2** by squeezing locking tabs **3** together at top and bottom.<

- Lift the seat up to remove.
- Place the seat, upholstered side down, on a clean surface.

Installing front seat

with OE Seat heating:

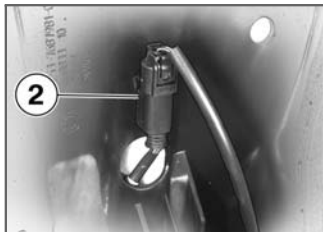

- Connect plug **2**.◀

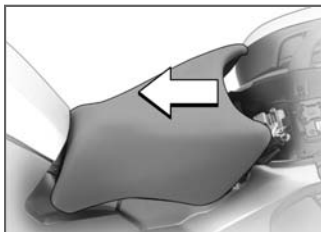

! If too much pressure is applied in the forward direction, there is a danger that the motorcycle will be pushed off its stand.

Always make sure that the motorcycle is stable and firmly supported.◀

- Push the front seat forward into the seat height adjuster. Make sure that the seat is correctly located.
- Install the rear seat (▬▶ 75)

Installing rear seat

- Install the front seat (▬▶ 75) with OE Seat heating:



- Connect plug **2**.◀

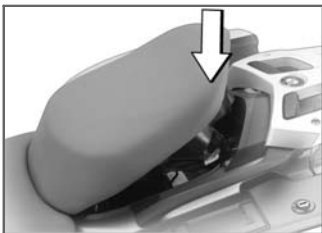

! If too much pressure is applied in the forward direction, there is a danger that the motorcycle will be pushed off its stand.

Always make sure that the motorcycle is stable and firmly supported. ◀

- Slide the rear seat underneath the front seat and push it down firmly at the rear.
- » The seat engages with an audible click.

Helmet holder

Securing helmet to motorcycle

- Remove the rear seat (➡ 73)



- Use the wire rope available as an optional accessory to secure the helmet to helmet holder **1**.

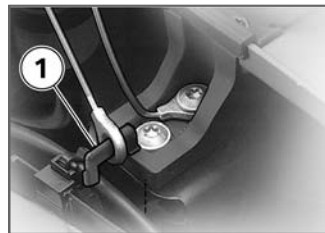

! The helmet catch can scratch the panelling. Make sure the lock is out of the way when you hook the helmet into position. ◀

- Secure one end of the wire rope, pass the wire rope through the helmet and slip the other end over holder **1**.
- Install the rear seat (➡ 75)

Riding

Safety instructions	78
Checklist	80
Starting	80
Running in	83
Brakes	84
Parking your motorcycle	85
Refuelling	87

Safety instructions

Rider's equipment

Do not ride without the correct clothing. Always wear:

- Helmet
- Motorcycling jacket and trousers
- Gloves
- Boots

This applies even to short journeys, and to every season of the year. Your authorised BMW Motorrad dealer will be glad to advise you on the correct clothing for every purpose.

Speed

If you ride at high speed, always bear in mind that various boundary conditions can adversely affect the handling of your motorcycle:

- Settings of the spring-strut and shock-absorber system
- Imbalanced load
- Loose clothing
- Insufficient tyre pressure
- Poor tyre tread
- Etc.

Correct loading



Overloading and imbalanced loads can adversely affect the motorcycle's handling. Do not exceed the permissible gross weight and be sure to comply with the instructions on loading.◀

Alcohol and drugs



Even small amounts of alcohol or drugs will adversely affect your perception and your ability to assess situations and make decisions, and slow down your reflexes. Medication can exacerbate these effects.

Do not ride your motorcycle after consuming alcohol, drugs and/or medication.◀

Risk of poisoning

Exhaust fumes contain carbon monoxide, which is colourless and odourless but highly toxic.



Inhaling the exhaust fumes therefore represents a health hazard and can even cause loss of consciousness with fatal consequences.

Do not inhale exhaust fumes. Do not run the engine in an enclosed space.◀

High voltage



Touching live parts of the ignition system with the engine running can cause electric shock.

Do not touch parts of the ignition system when the engine is running.◀

Catalytic converter

If misfiring causes unburned fuel to enter the catalytic converter, there is a danger of overheating and damage.

For this reason, observe the following points:

- Do not run the fuel tank dry.
- Do not attempt to start or run the engine with a spark-plug cap disconnected.
- Stop the engine immediately if it misfires.
- Use only unleaded fuel.
- Comply with all specified maintenance intervals.

 Unburned fuel will destroy the catalytic converter. Note the points listed for protection of the catalytic converter.◀

Risk of fire

Temperatures at the exhaust are high.

 Flammable materials (e.g. hay, leaves, grass, clothing and luggage, etc.) could ignite if allowed to come into contact with the hot exhaust pipe.

Do not permit flammable materials to come into contact with the hot exhaust system.◀

 Cooling would be inadequate if the engine were allowed to idle for a lengthy period with the motorcycle at a standstill: overheating would result. In extreme cases, the motorcycle could catch fire.

Do not allow the engine to idle unnecessarily. Ride away immediately after starting the engine.◀

Tampering with the control unit of the electronic engine-management system

 Tampering with the engine control unit can damage the motorcycle and cause accidents.

Do not tamper with the engine control unit.◀

 Tampering with the engine control unit can result in mechanical loads that the motorcycle's components are not designed to withstand. Damage caused in this way is not covered by the warranty.

Do not tamper with the engine control unit.◀

Checklist

Use the following checklist to check important functions, settings and wear limits before you ride off.

- Brakes
- Brake-fluid levels, front and rear
- Clutch
- Clutch fluid level
- Shock absorber setting and spring preload
- Tyre-tread depth and tyre pressures
- Cases correctly installed and luggage secured

At regular intervals:

- Engine oil level (every refuelling stop)
- Brake-pad wear (every third refuelling stop)

Starting

Side stand

You cannot start the motorcycle with the side stand extended and a gear engaged. The engine will switch itself off if you start it with the gearbox in neutral and then engage a gear before retracting the side stand.

Gearbox

You can start the engine when the gearbox is in neutral or if you pull the clutch with a gear engaged. Do not pull the clutch until after you have switched on the ignition, as otherwise the engine will refuse to start. When the gearbox is in neutral, the green neutral telltale light is on and the gear indicator in the multifunction display shows N.

Starting engine.

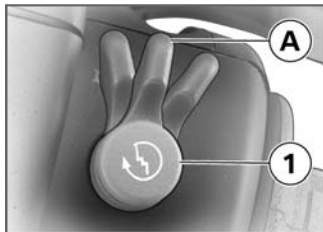

- Kill switch **1** in run position **A**.
- Switch on the ignition.
 - » Pre-ride check is performed. (☛ 81)
 - » ABS self-diagnosis is performed. (☛ 82)

with OE ASC:

- Switch on the ignition.
 - » Pre-ride check is performed. (☛ 81)
 - » ABS self-diagnosis is performed. (☛ 82)

» ASC self-diagnosis is performed. (➡ 82)◀



• Press starter button **1**.

▶ If ambient temperatures are very low, you might find it necessary to open the throttle slightly when starting the engine. At ambient temperatures below 0 °C, disengage the clutch after switching on the ignition.◀

▶ The start attempt is automatically interrupted if battery voltage is too low. Recharge the battery before you start the

engine, or use jump leads and a donor battery to start.◀

» The engine starts.

» Consult the troubleshooting chart below if the engine refuses to start. (➡ 142)

Pre-ride check

The instrument cluster runs a test of the 'General' warning light when the ignition is switched on: this is the "Pre-Ride-Check" The warning light shows first red and then yellow, so that you can check that it is in working order. The test is aborted if you start the engine before it completes.

Phase 1

⚠ General warning light shows red.

– CHECK ! appears on the display.

Phase 2

⚠ General warning light shows yellow.

– CHECK ! appears on the display.

SET If the motorcycle is equipped with cruise control, SET lights up.

If the 'General' warning light does not show:

⚠ Some malfunctions cannot be indicated if the 'General' warning light cannot be displayed.

Check that the 'General' warning light comes on, and that it shows red and yellow.◀

• Have the fault rectified as quickly as possible by a specialist workshop, preferably an authorised BMW Motorrad dealer.

ABS self-diagnosis

BMW Motorrad Integral ABS performs self-diagnosis to ensure its operability. Self-diagnosis is performed automatically when you switch on the ignition. The motorcycle has to move forward at a speed above 5 km/h for the wheel sensors to be tested.

Phase 1

» Test of the diagnosis-compatible system components with the motorcycle at a standstill.



ABS warning light flashes.



Possible national variant of the ABS warning light.

Phase 2

» Test of the wheel sensors as the motorcycle pulls away from rest.



ABS warning light flashes.



Possible national variant of the ABS warning light.

ABS self-diagnosis completed

» The ABS warning light goes out.

If an indicator showing an ABS fault appears when ABS self-diagnosis completes:

- You can continue to ride. Bear in mind that neither the ABS function nor the integral braking function is available.
- Have the fault rectified as quickly as possible by a specialist workshop, preferably an authorised BMW Motorrad dealer.

ASC self-diagnosis^{OE}

BMW Motorrad ASC performs self-diagnosis to ensure its op-

erability. Self-diagnosis is performed automatically when you switch on the ignition. The engine must be running and the motorcycle must reach a speed of at least 5 km/h in order for ASC self-diagnosis to complete.

Phase 1

» Test of the diagnosis-compatible system components with the motorcycle at a standstill.



ASC warning light slow-flashes.

Phase 2

» Test of the diagnosis-compatible system components while the motorcycle is on the move.



ASC warning light slow-flashes.

ASC self-diagnosis completed

» The ASC warning light goes out.

If an indicator showing an ASC fault appears when ASC self-diagnosis completes:

- You can continue to ride. Bear in mind that the ASC function is not available.
- Have the fault rectified as quickly as possible by a specialist workshop, preferably an authorised BMW Motorrad dealer.

Running in

The first 1000 km

- While running in the motor-cycle, vary the throttle opening and engine-speed range frequently.
- Try to do most of your riding during this initial period on twisting, fairly hilly roads, avoiding high-speed main roads and highways if possible.



Exceeding the specified engine speeds while running in will lead to increased engine wear.

Keep to the specified engine speeds for running in.◀

- Do not exceed the rpm limits recommended for running in.



Running-in speed

– <7000 min⁻¹

- No full-load acceleration.
- Avoid low engine speeds at full load.
- Do not omit the first inspection after 500 - 1200 km.

Brake pads

New brake pads must "bed down" and therefore do not achieve their optimum friction levels during the first 500 km. You can compensate for this initial reduction in braking

efficiency by exerting greater pressure on the levers.



New brake pads can extend stopping distance by a significant margin.

Apply the brakes in good time.◀

Tyres

New tyres have a smooth surface. This must be roughened by riding in a restrained manner at various heel angles until the tyres are run in. This running in procedure is essential if the tyres are to achieve maximum grip.



Tyres do not have their full grip when new and there is a risk of accidents at extreme angles of heel.

Avoid extreme angles of heel.◀

Brakes

How can stopping distance be minimised?

Each time the brakes are applied, a load distribution shift takes place with the load shifting forward from the rear to the front wheel. The sharper the motorcycle decelerates, the more load is shifted to the front wheel. The higher the wheel load, the more braking force can be transmitted without the wheel locking.

To optimise stopping distance, apply the front brakes rapidly and keep on increasing the force you apply to the brake lever. This makes the best possible use of the dynamic increase in load at the front wheel. Remember to pull the clutch at the same time. In the "panic braking situations" that are trained so frequently braking force is applied as rapidly as possible and with

the rider's full force applied to the brake levers; under these circumstances the dynamic shift in load distribution cannot keep pace with the increase in deceleration and the tyres cannot transmit the full braking force to the surface of the road. ABS has to intervene to keep the front wheel from locking; this increases stopping distance.

Descending mountain passes

 There is a danger of the brakes fading if you use only the rear brakes when descending mountain passes. Under extreme conditions, the brakes could overheat and suffer severe damage.

Use both front and rear brakes, and make use of the engine's braking effect as well.◀

Wet brakes

 After the motorcycle has been washed, ridden through water or ridden in the rain, the brake discs and pads might be wet and the brakes might not take effect immediately.

Apply the brakes in good time until the brakes have dried out.◀

Salt on brakes

 The brakes may fail to take effect immediately if the motorcycle was ridden on salt-covered roads and the brakes were not applied for some time. Apply the brakes in good time until the salt layer on the brake discs and brake pads has been removed.◀

Oil or grease on brakes



Oil and grease on the brake discs and pads considerably diminish braking efficiency.

Especially after repair and maintenance work, make sure that the brake discs and brake pads are free of oil and grease. ◀

Dirt or mud on brakes



When riding on loose surfaces or muddy roads, the brakes may fail to take effect immediately because of dirt or moisture on the discs or brake pads.

Apply the brakes in good time until the brakes have been cleaned. ◀

Parking your motorcycle

Placing motorcycle on side stand



If the ground is soft or uneven, there is no guarantee that the motorcycle will rest firmly on the stand.

Always check that the ground under the stand is level and firm. ◀

- Switch off the engine.
- Pull the handbrake lever.
- Hold the motorcycle upright and balanced.
- Use your left foot to extend the side stand fully.



The side stand is designed to support only the weight of the motorcycle.

Do not lean or sit on the motorcycle with the side stand extended. ◀

- Slowly lean the motorcycle to the side until its weight is taken by the stand and dismount to the left.



If the motorcycle is on the side stand, the surface of the ground will determine whether it is better to turn the handlebars to the left or right. However, the motorcycle is more stable on a level surface with the handlebars turned to the left than with the handlebars turned to the right.

On level ground, always turn the handlebars to the left to set the steering lock. ◀

- Turn the handlebars to full left or right lock.
- Check that the motorcycle is standing firmly.



On a gradient, the motorcycle should always face uphill; select 1st gear. ◀

- Lock the steering lock.

Removing motorcycle from side stand

- Unlock the steering lock.
- From the left, grip the handlebars with both hands.
- Pull the handbrake lever.
- Swing your right leg over the seat and lift the motorcycle to the upright position.
- Hold the motorcycle upright and balanced.

 An extended side stand can catch on the ground when the motorcycle is moving and lead to a fall.

Retract the side stand before moving the motorcycle.◀

- Sit on the motorcycle and use your left foot to retract the side stand.

Placing motorcycle on centre stand

 If the ground is soft or uneven, there is no guarantee that the motorcycle will rest firmly on the stand. Always check that the ground under the stand is level and firm.◀

- Switch off the engine.
- Dismount and keep your left hand on the left handlebar grip.
- With your right hand, grip the rear grab handle or the rear frame.
- Use your right foot on the pin of the centre stand to press the stand down until its curved feet touch the ground.
- Place your full body weight on the centre stand and at the same time pull the motorcycle to the rear.



Excessive movements could cause the centre stand to retract, and the motorcycle would topple in consequence.

Do not lean or sit on the motorcycle with the centre stand extended.◀

- Check that the motorcycle is standing firmly.
- Lock the steering lock.

Removing motorcycle from centre stand

- Unlock the steering lock.
- Place your left hand on the left handlebar grip.
- With your right hand, grip the rear grab handle or the rear frame.
- Push the motorcycle forward off the centre stand.
- Check that the centre stand has fully retracted.

Refuelling

 Fuel is highly flammable. A naked flame close to the fuel tank can cause a fire or explosion.

Do not smoke. Never bring a naked flame near the fuel tank. ◀

 Fuel expands when hot. Fuel escaping from an overfilled tank could make its way onto the rear tyre. This could cause a fall.

Do not fill the tank past the bottom edge of the filler neck. ◀

 Fuel attacks plastics, which become dull or unsightly. Wipe off plastic parts immediately if they come into contact with fuel. ◀

 Fuel can attack the material of the windscreen and the side slipstream deflectors, which become dull or unsightly. Wipe off the windscreen and slip-

stream deflectors immediately if they come into contact with fuel. ◀

 Leaded fuel will destroy the catalytic converter. Use only unleaded fuel. ◀

- Make sure the ground is level and firm and place the motorcycle on its stand.

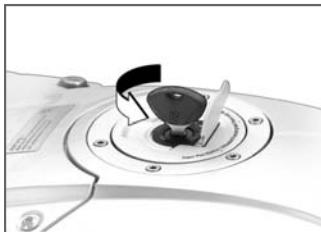

- Open the protective cap.
- Open the fuel tank cap with the ignition key by turning it counter-clockwise.
- Refuel with fuel of the grade stated below; do not fill the

tank past the bottom edge of the filler neck.

 Recommended fuel grade

– 98 ROZ/RON (Premium plus unleaded)

– 95 ROZ/RON (Premium unleaded (fuel grade, usable with power- and consumption-related restrictions))

 Usable fuel capacity

– 24 l

 Reserve fuel

– ≥ 4 l

- Press the filler cap down firmly to close.
- Remove the key and close the protective cap.

Engineering details

Brake system with BMW Motorrad Integral ABS	90
Electronic engine management with BMW Motorrad ASC ^{OE}	92
Tyre pressure monitoring RDC ^{OE}	94

Brake system with BMW Motorrad Integral ABS

Partially integral brakes

Your motorcycle is equipped with partially integral brakes. Both front and rear brakes are applied when you pull the handbrake lever. The footbrake lever acts only on the rear brake.

While the brakes are slowing the motorcycle, the BMW Motorrad Integral ABS adapts braking-force distribution between front and rear brakes to suit the load on the motorcycle.



The integral braking function makes it very difficult to spin the rear wheel by opening the throttle with the front brake applied to keep the motorcycle stationary (burn-out). Attempted burn-outs can result in damage to the rear brake and the clutch. Do not attempt burn-outs. ◀

How does ABS work?

The amount of braking force that can be transferred to the road depends on factors that include the coefficient of friction of the road surface. Loose stones, ice and snow or a wet road all have much lower coefficients of friction than a clean, dry asphalt surface. The lower the coefficient of friction, the longer the braking distance.

If the rider increases braking pressure to the extent that braking force exceeds the maximum transferrable limit, the wheels start to lock and the motorcycle loses its directional stability; a fall is imminent. Before this situation can occur, ABS intervenes and adapts braking pressure to the maximum transferrable braking force, so the wheels continue to turn and directional stability is maintained irrespective of the condition of the road surface.

What are the effects of surface irregularities?

Humps and surface irregularities can cause the wheels to lose contact temporarily with the road surface; if this happens the braking force that can be transmitted to the road can drop to zero. If the brakes are applied under these circumstances the ABS has to reduce braking force to ensure that directional stability is maintained when the wheels regain contact with the road surface. At this instant the BMW Motorrad Integral ABS must assume an extremely low coefficient of friction, so that the wheels will continue to rotate under all imaginable circumstances, because this is the precondition for ensuring directional stability. As soon as it registers the actual circumstances, the system reacts instantly and adjusts brak-

ing force accordingly to achieve optimum braking.

What feedback does the rider receive from the BMW Motorrad Integral ABS?

If the ABS system has to reduce braking force on account of the circumstances described above, vibration is perceptible through the handbrake lever.

When the handbrake lever is pulled, brake pressure is also built up at the rear wheel by the integral function. If the brake pedal is depressed after the handbrake lever is pulled, the brake pressure built up beforehand is perceptible as counter-pressure sooner than is the case when the brake pedal is depressed either before or at the same time as the brake lever is pulled.

Rear wheel lift

Even under severe braking, a high level of tyre grip can mean that the front wheel does not lock up until very late, if at all. Consequently, ABS does not intervene until very late, if at all. Under these circumstances the rear wheel can lift off the ground, and the outcome can be a high-siding situation in which the motorcycle can flip over.



Severe braking can cause the rear wheel to lift off the ground.

When you brake, bear in mind that ABS control cannot be relied on in all circumstances to prevent the rear wheel from lifting clear of the ground.◀

What is the design baseline for BMW Motorrad Integral ABS?

Within the limits imposed by physics, the BMW Motorrad Integral ABS ensures directional stability on any surface. The system is not optimised for special requirements that apply under extreme competitive situations off-road or on the track.

Special situations

The speeds of the front and rear wheels are compared as one means of detecting a wheel's incipient tendency to lock. If the system registers implausible values for a lengthy period the ABS function is deactivated for safety reasons and an ABS fault message is issued. Self-diagnosis has to complete before fault messages can be issued.

In addition to problems with the BMW Motorrad Integral ABS,

exceptional riding conditions can lead to a fault message being issued.

Exceptional riding conditions:

- Heating up with the motorcycle on the centre stand or an auxiliary stand, engine idling or with a gear engaged.
- Rear wheel locked by the engine brake for a lengthy period, for example while descending off-road.

If a fault message is issued on account of exceptional riding conditions as outlined above, you can reactivate the ABS function by switching the ignition off and on again.

What significance devolves on regular maintenance?



Invariably, a technical system cannot perform beyond the abilities dictated by its level of maintenance.

In order to ensure that the BMW Motorrad ABS is always maintained in optimum condition, it is essential for you to comply strictly with the specified inspection intervals. ◀

Reserves for safety

The potentially shorter braking distances which BMW Motorrad Integral ABS permits must not be used as an excuse for careless riding. ABS is primarily a means of ensuring a safety margin in genuine emergencies.

Take care when cornering. When you apply the brakes on a corner, the motorcycle's weight and

momentum take over and even BMW Motorrad Integral ABS is unable to counteract their effects.

Electronic engine management with BMW Motorrad ASC^{OE}

How does ASC work?

The BMW Motorrad ASC compares the speed of rotation of the front wheel and the rear wheel. The differential is used to compute slip as a measure of the reserves of stability available at the rear wheel. If slip exceeds a certain limit the electronic engine management system intervenes, adapting engine torque accordingly.

What is the design baseline for BMW Motorrad ASC?

BMW Motorrad ASC is designed as an assistant system for the rider and for use on public roads. The extent to which the rider affects ASC control can be considerable (weight shifts when cornering, items of luggage loose on the motorcycle), especially when style of riding takes rider and machine close to the limits imposed by physics. The system is not optimised for special requirements that apply under extreme competitive situations off-road or on the track. You have the option of deactivating the BMW Motorrad ASC system for these circumstances.



Even ASC is constrained by the laws of physics. Invariably, the rider bears responsibility for assessing road and traffic

conditions and adopting his or her style of riding accordingly. Do not take risks that would negate the additional safety offered by this system. ◀

Special situations

In accordance with the laws of physics, the ability to accelerate is restricted more and more as the angle of heel increases. Consequently, there can be a perceptible lag in acceleration out of very tight bends.

The speeds of the front and rear wheels are compared as one means of detecting the rear wheel's incipient tendency to spin or slip sideways. If the system registers implausible values for a lengthy period the ASC function is deactivated for safety reasons and an ASC fault message is issued. Self-diagnos-

is has to complete before fault messages can be issued. The BMW Motorrad ASC can shut down automatically under the exceptional riding conditions outlined below.

Exceptional riding conditions:

- Riding for a lengthy period with the front wheel lifted off the ground (wheelie) and ASC deactivated.
- Rear wheel rotating with the motorcycle held stationary by applying the front brake (burn-out).
- Heating up with the motorcycle on the centre stand or an auxiliary stand, engine idling or with a gear engaged.

Accelerating the motorcycle to a speed in excess of 10 km/h after switching the ignition off and then on again reactivates the ASC.

If the front wheel lifts clear of the ground under severe acceleration, the ASC reduces engine torque until the front wheel regains contact with the ground. Under these circumstances, BMW Motorrad recommends rolling the throttle slightly closed so as to restore stability with the least possible delay.

When riding on a slippery surface, never snap the throttle twistgrip fully closed without pulling the clutch at the same time. Engine braking torque can cause the rear wheel to lock, with a corresponding loss of stability. The BWM Motorrad ASC is unable to control a situation of this nature.

Tyre pressure monitoring RDC^{OE}

Function

A sensor integrated into each tyre measures the air temperature and the air pressure inside the tyre and transmits this information to the control unit. Each sensor has a centrifugal-force tripswitch that does not enable transmission of the measured values until the motorcycle has accelerated to about 30 km/h. The display shows -- for each tyre until the tyre-pressure signal is received for the first time. The sensors continue to transmit the measured-value signals for approximately 15 minutes after the motorcycle comes to a stop.

The control unit can administer four sensors, so two different sets of wheels with RDC sensors can be alternated on

the motorcycle. An error message is issued if wheels without sensors are fitted to a motorcycle equipped with an RDC control unit.

Temperature compensation

The tyre-pressure readings shown by the multifunction display are temperature-compensated; the reference tyre temperature for these readings is always 20 °C. The air lines available to the public in petrol stations and motorway service areas almost invariably show temperature-dependent tyre pressures, so in most instances these gauge readings will not tally with the readings shown by the multifunction display.

Tyre-pressure ranges

The RDC control unit differentiates between three air-pressure ranges, all of which are parameterised for the motorcycle:

- Air pressure within permitted tolerance.
- Air pressure close to limit of permitted tolerance.
- Air pressure outside permitted tolerance.

Accessories

General instructions.....	98
Power socket	98
Luggage	99
Case	100
Topcase ^{OA}	102

General instructions

BMW Motorrad recommends the use of parts and accessories for your motorcycle that are approved by BMW for this purpose. Genuine BMW parts and accessories and other products which BMW has approved can be obtained from your authorised BMW Motorrad dealer, together with expert advice on their installation and use.

These parts and products have been tested by BMW for safety, function and suitability. BMW accepts product liability for them. Conversely, BMW is unable to accept any liability whatsoever for parts and accessories which it has not approved.

 BMW Motorrad cannot assess each non-BMW product to determine whether it can be used on or in connection with BMW motorcycles

without constituting a safety hazard. Country-specific official authorisation does not suffice as assurance. Tests conducted by these instances cannot make provision for all operating conditions experienced by BMW motorcycles and, consequently, they are not sufficient in some circumstances.

Use only parts and accessories approved by BMW for your motorcycle. ◀

Whenever you are planning modifications, comply with all the legal requirements. Make sure that the motorcycle does not infringe national road-vehicle construction and use regulations.

Power socket

Ratings



The supply to standard socket **1** and the extra socket (OA) is cut off automatically if battery voltage is low or the load exceeds the maximum for the two sockets.

Operating electrical accessories

You can start using electrical accessories only when the ignition is switched on. The accessory remains operational if the ignition is subsequently switched off. In order to ensure that the drain on

the on-board power supply system is minimised, the supply to the power socket is cut off approximately 15 minutes after the ignition is switched off, and it is also temporarily interrupted during the start procedure.

Cable routing

The cables from the power socket to the auxiliary device must be routed in such a way that they:

- Do not impede the rider
- Do not restrict or obstruct the steering angle and handling characteristics
- Cannot be trapped



Incorrectly routed cables can impede the rider.

Route the cables as described above. ◀

Luggage

Correct loading



Overloading and imbalanced loads can adversely affect the motorcycle's handling. Do not exceed the permissible gross weight and be sure to comply with the instructions on loading. ◀

- Set spring preload, damping characteristic and tyre pressures to suit total weight.
- Adjust the spring preload for rear wheel (▶▶▶ 68)
- Check the tyre pressure (▶▶▶ 72)
- Adjust the damping for rear wheel (▶▶▶ 69)
- Ensure that the case volumes on the left and right are equal.
- Make sure that the weight is uniformly distributed between right and left.

- Pack heavy items at the bottom and toward the inboard side.
- Note the maximum permissible payload of the cases and the speed limit for riding with cases on the motorcycle.



Payload of cases

- ≤8 kg



Maximum permissible speed for riding with cases fitted to the motorcycle

- ≤180 km/h



Payload of topcase

with OA Topcase:



Payload of topcase

- $\leq 5 \text{ kg}$



Payload of topcase

with OA Large topcase:

- $\leq 10 \text{ kg}$



Maximum permissible speed for riding with topcase fitted to the motorcycle

with OA Topcase:

- $\leq 180 \text{ km/h}$

- Note the maximum permissible payload of the tank rucksack.



Payload of tank rucksack

with OA Tank rucksack:

- $\leq 5 \text{ kg}$

Case

Opening cases



- Turn the key to the OPEN position in the case lock.
- » The case is unlocked.

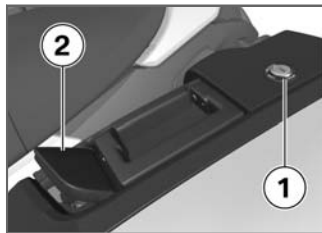

- Press lock barrel **1**.

- » Lever **2** pops up.
- Pull the release lever up.
- » The lid of the case opens.

Close the case



- Pull release lever **2** all the way up.
- Close the lid of the case and press it down. Check that nothing is trapped between the lid and the case.

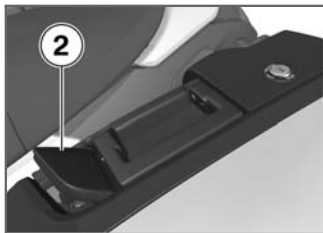

- Push release lever **2** down.
» The release lever engages.
- Turn the key to the LOCK position in the case lock.
» The case is closed.

Removing case



- Turn the key to the RELEASE position in the case lock.
» The handle pops out.

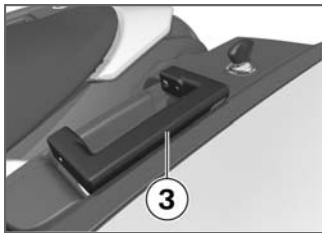

- Pull handle **3** out and then pull it up as far as it will go.

» The case is released and can be removed.

Install the case

- Pull the handle up as far as it will go.

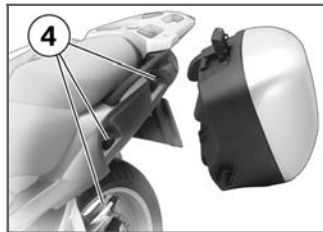

- Seat the case in holders **4**.



- Push handle **3** down until it engages.
- » The case is correctly engaged on its holders.
- Turn the key to the LOCK position in the case lock.
- » The case is closed.
- Check that the case is secure.

Topcase^{OA}

Open the topcase



- Turn the key to the OPEN position in the topcase lock.
- » The topcase is unlocked.

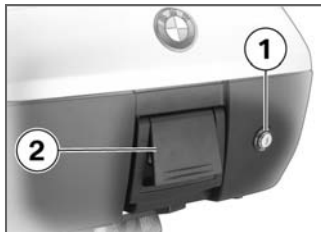

- Press lock barrel **1**.

- » Lever **2** pops up.
- Pull the release lever up.
- » The lid of the topcase opens.

Close the topcase



- Pull release lever **2** all the way up.
- Close the lid of the topcase and press it down. Check that nothing is trapped between the lid and the case.



- Push release lever **2** down.
» The release lever engages.
- Turn the key to the LOCK position in the topcase lock.
» The topcase is locked.

Remove the topcase

- Turn the key to the RELEASE position in the topcase lock.
» The handle pops out.



- Pull handle **3** up as far as it will go.
- Lift the topcase at the rear and pull it off the luggage carrier.

Install the topcase

- Pull the handle up as far as it will go.

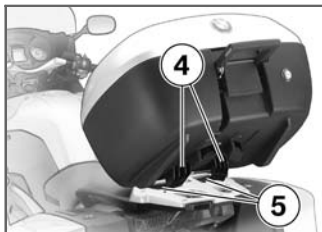

- Hook the topcase into position on the luggage carrier. Make sure that hooks **4** are securely seated in the corresponding keepers **5**.



- Push handle **3** down until it engages.
 - » The topcase is correctly engaged on its carrier.
- Turn the key to the LOCK position in the topcase lock.
 - » The topcase is locked.
- Check that the topcase is secure.

Maintenance

General instructions.....	106
Toolkit	106
Engine oil	107
Brake system, general	109
Brake pads	109
Brake fluid	111
Clutch	113
Tyres	113
Rims.....	114
Wheels	114
Front-wheel stand	121
Bulbs	123
Jump starting	131
Battery.....	132

General instructions

The Maintenance chapter describes straightforward procedures for checking and replacing certain wear parts.

Special tightening torques are listed as applicable. The tightening torques for the threaded fasteners on your motorcycle are listed in the section entitled "Technical data".

You will find information on more extensive maintenance and repair work in the Repair Manual on DVD/CD-ROM (RepROM) for your motorcycle, which is available from your authorised BMW Motorrad dealer.

Some of the work calls for special tools and a thorough knowledge of motorcycles. If you are in doubt consult a specialist workshop, preferably your authorised BMW Motorrad dealer.

Toolkit

Standard on-board toolkit

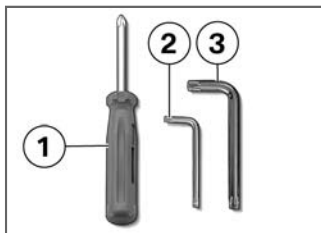

1 Screwdriver with reversible blade

- Removing and installing front turn indicator glass
- Disconnecting leads from battery terminals

2 Torx wrench, T25

- Removing and installing body panels
- Removing and installing battery retainer

- Removing and installing brake-light, rear-light and rear-indicator bulbs

3 Torx wrench, T45

- Adjusting handlebars

On-board toolkit service kit

Your authorised BMW Motorrad dealer can provide the on-board toolkit service kit that you will need if you are considering undertaking more extensive work. You will find information on undertaking work of this nature in the Repair Manual on the DVD/CD-ROM also obtainable from your authorised BMW Motorrad dealer.

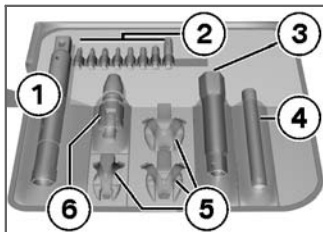

1 Extending tool holder

- Adapters to accommodate all tools

2 1/4" bits

- 5x Torx, for example for removing and installing rear wheel
- 2x cross-head bits
- 1x plain screwdriver bit

3 3/8" adapter for socket-head screws, w/f 22

- Removing and installing front axle

4 Electric torch

- LED bulb

5 Socket

- 3x open-ended spanners, various sizes

6 Bit adapter

- Adapter for 1/4" bits
- 9x12 mm and 3/8" swivel adapters

Engine oil

Checking engine oil level



The engine can seize if the oil level is low, and this can lead to accidents.

Always make sure that the oil level is correct. ◀



Oil can collect in the sump if the motorcycle is out of use for an extended period of time; this oil has to be pumped into the oil tank before the level is read. The engine oil must be

at operating temperature to do this. Checking the oil level with the engine cold or after no more than a short ride will lead to misinterpretation; this in turn, means that the engine will be operated with the incorrect quantity of oil. In order to ensure that the engine oil level is read correctly, check the oil level only after a lengthy trip. ◀

- Check that the engine is at operating temperature, make sure the ground is level and firm and place the motorcycle on its centre stand.
- Allow the engine to idle for one minute.
- Switch off the ignition
- Remove the front seat (➡ 74)
- Wipe the area around the oil filler neck clean.

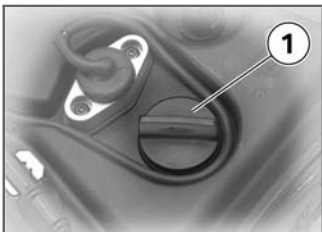

- Remove oil filler cap **1** by turning it counter-clockwise.



- Use a dry cloth to wipe oil dipstick **2** clean

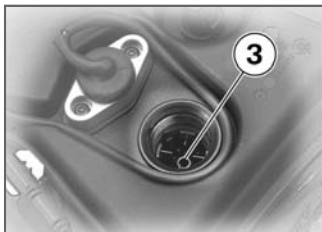

- Seat the oil dipstick on the oil filler neck, but do not engage the threads. Make sure that the dipstick is seated in guide **3**.
- Remove the oil dipstick and check the oil level.

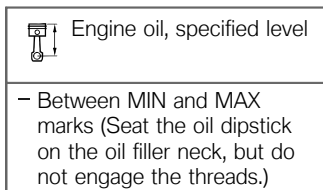
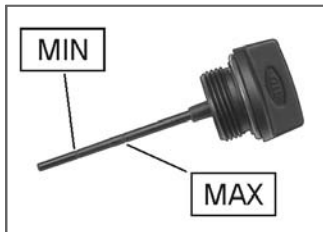

If the oil level is below the MIN mark:

- Top up the engine oil.

If the oil level is above the MAX mark:

- Have the oil level corrected by a specialist workshop, prefer-

ably an authorised BMW Motorrad dealer.

- Install the oil dipstick.
- Install the front seat (➡ 75)

Topping up engine oil



- Pour engine oil in through filler neck **1** until it reaches the specified level.
- Check the engine oil level (➡ 107)

Brake system, general

Reliability

A fully functional brake system is a basic requirement for the road safety of your motorcycle.

Do not ride the motorcycle if you have any doubts about the dependability of the brake system. Under these circumstances have the brake system checked by a specialist workshop, preferably an authorised BMW Motorrad dealer.

 Incorrect working practices endanger the reliability of the brakes.

Have all work on the brake system performed by a specialist workshop, preferably an authorised BMW Motorrad dealer. ◀

Checking operation of brakes

- Pull the handbrake lever.

- » The pressure point must be clearly perceptible.
- Press the footbrake lever.
- » The pressure point must be clearly perceptible.

Brake pads

Checking front brake pad thickness

 Brake pads worn past the minimum permissible brake-pad thickness can cause a reduction in braking efficiency and under certain circumstances they can cause damage to the brake system.

In order to ensure the dependability of the brake system, do not permit the brake pads to wear past the minimum permissible brake-pad thickness. ◀

- Make sure the ground is level and firm and place the motorcycle on its stand.



- Visually inspect the left and right brake pads to ascertain their thickness. Viewing direction: Between wheel and front fork toward the brake caliper.

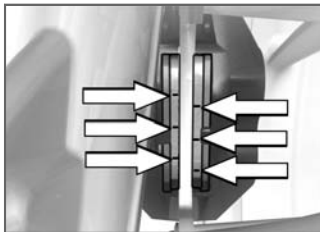

Brake-pad wear limit,
front

- min 1 mm (Friction pad only, without backing plate)
- The wear indicators (grooves) must be clearly visible.

If the wear indicating mark is no longer clearly visible:

- Have the brake pads replaced by a specialist workshop, preferably an authorised BMW Motorrad dealer.

Checking rear brake pad thickness



Brake pads worn past the minimum permissible brake-pad thickness can cause a reduction in braking efficiency and under certain circumstances they can cause damage to the brake system.

In order to ensure the dependability of the brake system, do not permit the brake pads to wear past the minimum permissible brake-pad thickness. ◀

- Make sure the ground is level and firm and place the motorcycle on its stand.

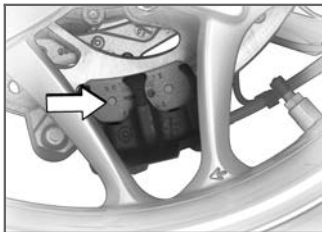

- Visually inspect the brake pads from the right to ascertain their thickness.



Brake-pad wear limit, rear

- min 1 mm (Wear limit, friction pad only, without backing plate)
- Make sure that the brake disc is not visible through the bore in the inboard brake pad.

If the brake disc is visible:

- Have the brake pads replaced by a specialist workshop, preferably an authorised BMW Motorrad dealer.

Brake fluid

Checking brake-fluid level, front brakes



A low fluid level in the brake reservoir can allow air to penetrate the brake system. This significantly reduces braking efficiency.

Check the brake-fluid level at regular intervals.◀

- Make sure the ground is level and firm and place the motorcycle on its centre stand.
- Turn the handlebars once from full left lock to full right lock and then centre the handlebars.

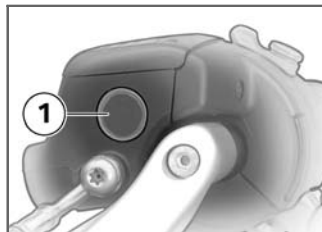

- Check the brake fluid level in brake fluid reservoir **1**.

▶ The brake fluid level in the brake fluid reservoir drops as the brake pads wear.◀



Brake fluid level, front

– DOT4 brake fluid

– Do not permit the brake fluid level to drop below the MIN mark. (Brake-fluid reservoir horizontal. Before reading the level, swing the handlebars once from full left lock to full right lock.)

If the brake fluid level drops below the permitted level:

- Have the defect rectified as quickly as possible by a spe-

cialist workshop, preferably an authorised BMW Motorrad dealer.

Checking brake-fluid level, rear brakes



A low fluid level in the brake reservoir can allow air to penetrate the brake system. This significantly reduces braking efficiency.

Check the brake-fluid level at regular intervals.◀

- Make sure the ground is level and firm and place the motorcycle on its centre stand.

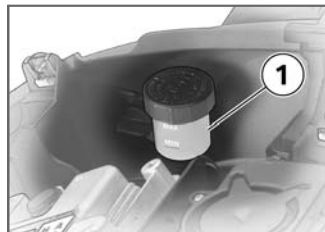

- Check the brake fluid level in brake fluid reservoir **1**.

▶ The brake fluid level in the brake fluid reservoir drops as the brake pads wear.◀

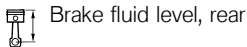
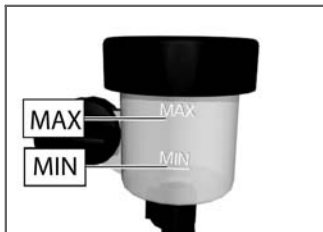

Brake fluid level, rear

– DOT4 brake fluid

– Do not permit the brake fluid level to drop below the MIN mark. (Brake-fluid reservoir horizontal)

If the brake fluid level drops below the permitted level:

- Have the defect rectified as quickly as possible by a specialist workshop, preferably an authorised BMW Motorrad dealer.

Clutch

Checking clutch operation

- Pull the clutch lever.
 - » The pressure point must be clearly perceptible.

If the pressure point is not clearly perceptible:

- Have the clutch checked by a specialist workshop, preferably an authorised BMW Motorrad dealer.

Tyres

Measuring tread depth of tyres

 Your motorcycle's handling and grip can be impaired even before the tyres wear to the minimum tyre tread depth permitted by law.

Have the tyres changed in good time before they wear to the minimum permissible tread depth.◀

- Make sure the ground is level and firm and place the motorcycle on its stand.
- Measure the tyre tread depth in the main tread grooves with wear marks.

 Tyres have wear indicators integrated into the main tread grooves. The tyre is worn out when the tyre tread has worn down to the level of the marks. The locations of the marks are indicated on the edge of the tyre, e.g. by the letters TI, TWI or by an arrow.◀

If the tyre tread no longer complies with the minimum legally required tread depth:

- Replace tyre or tyres, as applicable.

Rims

Visual inspection

- Make sure the ground is level and firm and place the motorcycle on its stand.
- Visually inspect the rims for defects.
- Have damaged rims checked and, if necessary, replaced by a specialist workshop, preferably an authorised BMW Motorrad dealer.

Wheels

Recommended tyres

For each size of tyre BMW Motorrad tests certain makes, and approves those that it certifies as roadworthy. If BMW Motorrad has not approved the wheels and tyres, it cannot assess their suitability or provide any guarantee of road safety.

Use only wheels and tyres approved by BMW Motorrad for your type of motorcycle.

You can obtain detailed information from your authorised BMW Motorrad dealer or on the Internet at www.bmw-motorrad.com.

RDC label^{OE}

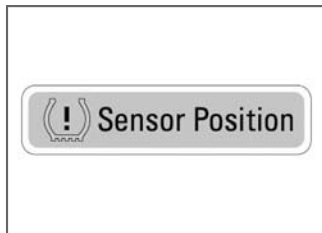

 Incorrect tyre-removal procedures can result in damage to the RDC sensors. Be sure to notify the authorised BMW Motorrad dealer or specialist workshop that the wheel is fitted with an RDC sensor.◀

If the motorcycle is equipped with RDC, each wheel rim bears an adhesive label indicating the position of the RDC sensor. When changing the tyre, take care not to damage the RDC sensor. Be sure to draw the attention of the authorised BMW Motorrad dealer or specialist workshop to the fact that the wheel is fitted with an RDC sensor.

Remove the front wheel

- Make sure the ground is level and firm and place the motorcycle on its centre stand.

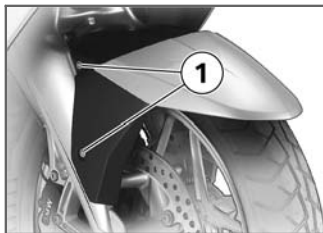

- Remove screws **1** on left and right.
- Pull the front mudguard forward to remove.



! Once the calipers have been removed, there is a risk of the brake pads being pressed together to the extent that they cannot be slipped back over the brake disc on reassembly.

Do not operate the handbrake lever when the brake calipers have been removed.◀

- Remove securing screws **2** of the left and right brake calipers.

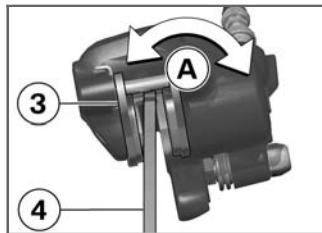

- Force the brake pads slightly apart by rocking brake calipers **3** back and forth **A** against brake discs **4**.
- Mask off the parts of the wheel rim that could be scratched in the process of removing the brake calipers.
- Carefully pull the brake calipers back and out until clear of the brake discs.
- When removing the left brake caliper, take care not to damage the ABS sensor cable.
- When removing the right brake caliper, take care not to alter

- the routing of the sensor cable of the brake-pad wear detector.
- Raise front of motorcycle until the front wheel can turn freely. BMW Motorrad recommends the BMW Motorrad front-wheel stand for lifting the motorcycle.
 - Install the front-wheel stand (➡ 122)

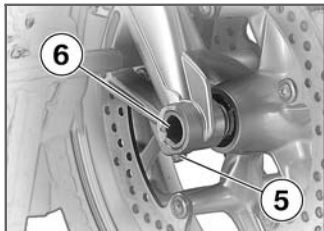

- Remove right-hand axle clamping screw **5**.

! The left axle clamping screw locates the threaded bush in the front suspension. If the threaded bush is not correctly aligned the gap

between the ABS sensor ring and the ABS sensor will not be correct and this can cause the ABS to malfunction or allow the ABS sensor to be damaged. In order to ensure that the threaded bush remains correctly aligned, do not slacken or remove the left axle clamping screw. ◀

- Remove quick-release axle **6**, while supporting the wheel.
- Lower the front wheel to the ground between the front forks.

! Take care not to damage the ABS sensor when rolling out the front wheel. Note the ABS sensor when rolling out the front wheel. ◀

- Roll the front wheel forward to remove.

Installing front wheel

! ABS malfunctions on account of incorrect speed signal.

Segmentation differs between individual types of sensor ring; it is very important to ensure that the correct sensor ring is installed. Install only the sensor ring that matches the motorcycle's construction status. ◀

! Threaded fasteners not tightened to the specified torque can work loose or their threads can suffer damage. Always have the security of the fasteners checked by a specialist workshop, preferably an authorised BMW Motorrad dealer. ◀

! The front wheel must be installed right way round to rotate in the correct direction. Note the direction-of-rotation arrows on the tyre or the wheel rim. ◀

 There is a risk of damaging parts of the front brake, particularly the BMW Motorrad Integral ABS, in the course of the procedure described below. Take care not to damage the brake system, in particular the ABS sensor with cable and the ABS sensor ring. ◀

 Take care not to damage the ABS sensor when rolling in the front wheel. Note the ABS sensor when rolling in the front wheel. ◀

- Roll the front wheel into position in the front suspension.

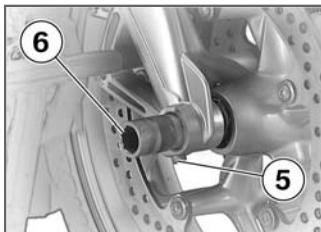

- Raise the front wheel, insert quick-release axle **6** and tighten to specified torque.

 Quick-release axle in threaded bush

– 50 Nm

- Tighten right axle clamping screw **5** to the specified tightening torque.

 Clamping screw for quick-release axle in wheel carrier

– 19 Nm

- Remove the front-wheel stand.



- Install securing screws **2** on left and right and tighten to specified tightening torque.

 Front brake caliper to wheel carrier

– 30 Nm

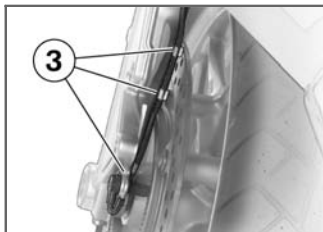

! The cable of the ABS sensor could chafe through if it comes into contact with the brake disc.

Make sure that the ABS sensor cable is routed correctly. ◀

- Clip the ABS sensor cable into three retaining clips **3**.



- Route the ABS sensor cable between the brake caliper and the front forks as illustrated here.
- Remove the adhesive tape from the wheel rim.

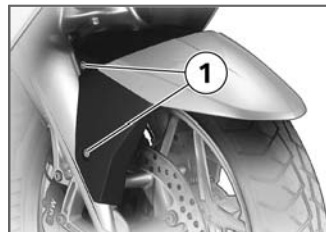

- Install the front mudguard and install screws **1** on left and right.
- Firmly pull the handbrake lever until the pressure point is perceptible, and repeat this operation several times.

Removing rear wheel

- Make sure the ground is level and firm and place the motorcycle on its centre stand.

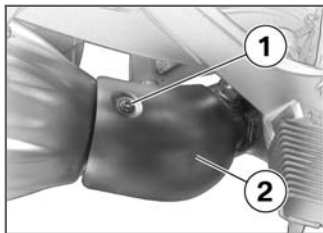

- Remove screw **1** from silencer cover **2**.
- Pull the cover to the rear to remove.

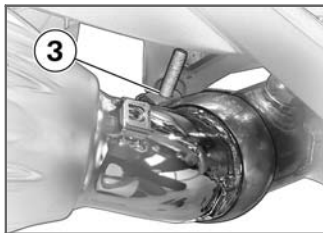

- Remove clamp **3** from the silencer.

- Do not remove the sealing grease from the clamp.

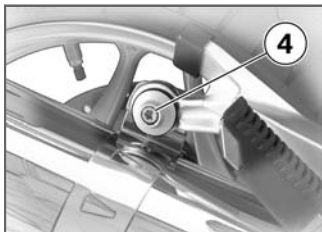

- Remove screw **4** for the bracket of the silencer from the rear footrest.
- Turn the silencer down.
- Engage first gear.

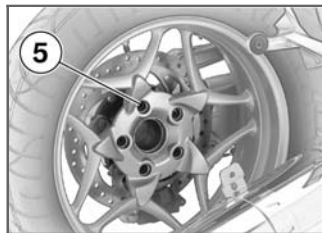

- Place a support underneath the rear wheel and remove studs **5**.
- Lower the rear wheel to the ground.
- Roll the rear wheel out toward the rear.

Installing rear wheel

 Threaded fasteners not tightened to the specified torque can work loose or their threads can suffer damage. Always have the security of the fasteners checked by a specialist workshop, preferably an authorised BMW Motorrad dealer.◀

- Roll the rear wheel into position at the rear-wheel adapter.
- Seat the rear wheel on the rear-wheel adapter.

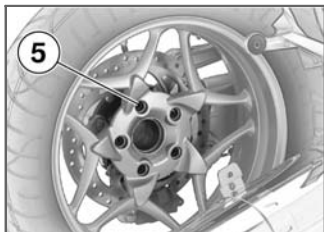

- Install wheel studs **5** and tighten to the specified torque in diagonally opposite sequence.



Rear wheel to wheel flange

– Tightening sequence: tighten in diagonally opposite sequence

– 60 Nm

- Turn the silencer to its initial position.

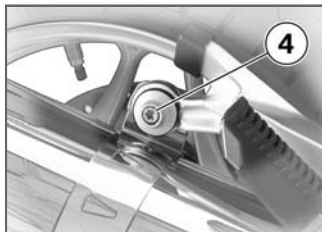

- Install screw **4** for the bracket of the silencer in the rear footrest, but do not tighten it at this point.

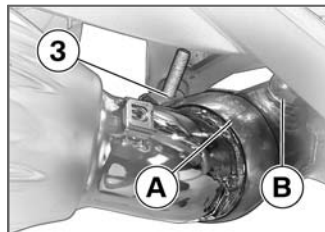

- Align clamp **3** on the silencer with mark **A** (arrow) on oxygen sensor **B**.
- Tighten clamp **3** on the silencer to the specified tightening torque.



Silencer to manifold

– 35 Nm

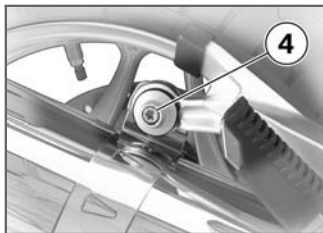

! If the gap between the rear wheel and the silencer is too small, the rear wheel can overheat.

The gap between the rear wheel and the silencer must be at least 15 mm. ◀

- Tighten screw **4** for the bracket of the silencer in the rear footrest to the specified torque.



Silencer to rear footrest

– 22 Nm

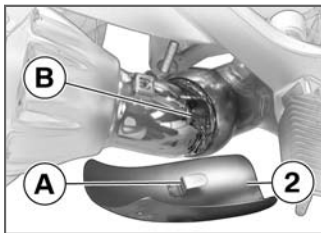

- Push silencer heat shield **2** with guide **A** into retainer **B**.

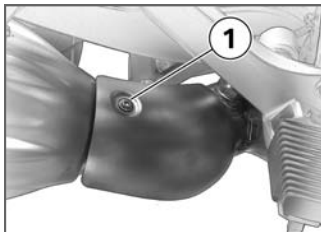

- Install screw **1** of the silencer heat shield.

Front-wheel stand

Use

A front-wheel stand for simple, safe changing of the front wheel is available from BMW Motorrad. The BMW special tool number is 36 3 971 and the front-wheel stand is available from your authorised BMW Motorrad dealer. You also need the adapters with the BMW special tool number 36 3 973.

! The BMW Motorrad front wheel stand is not designed to support motorcycles not fitted with a centre stand or without other auxiliary stands. A motorcycle resting only on the front wheel stand and the rear wheel can topple.

Place the motorcycle on its centre stand or another auxiliary stand before lifting the front wheel with the BMW Motorrad front-wheel stand. ◀

Installing front-wheel stand

- Make sure the ground is level and firm and place the motorcycle on its centre stand.

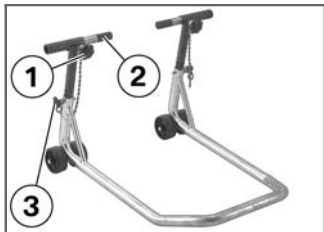

- Slacken adjusting screws **1**.
- Push the two pins **2** apart until the front suspension fits between them.
- Use locating pins **3** to set the front-wheel stand to the desired height.
- Centre the front-wheel stand relative to the front wheel and push it against the front axle.

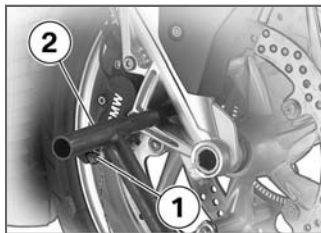

- Push both mounting pins **2** through the triangles of the brake caliper anchorages just far enough to allow the front wheel to be rolled between them.

! There is a risk of damaging the ABS sensor ring of the BMW ABS.

Push the pin in just far enough to ensure that it clears the sensor ring of the BMW ABS.◀

- Tighten adjusting screws **1**.

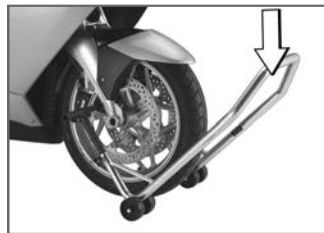

! If the motorcycle is raised too far the centre stand will lift clear of the ground and the motorcycle could topple to one side.

When raising the motorcycle, make sure that the centre stand remains on the ground.◀

- Apply uniform pressure to push the front-wheel stand down and raise the motorcycle.

Bulbs

General instructions

The failure of a bulb is signalled in the display by the defective lamp symbol. The bulbs for brake light and rear light are the same; the brightness of the light is regulated in accordance with the application.

 A defective bulb places your safety at risk because it is easier for other users to oversee the motorcycle.

Replace defective bulbs as soon as possible; always carry a complete set of spare bulbs if possible. ◀

 The bulb is pressurised and can cause injury if damaged.

Wear protective goggles and gloves when changing bulbs. ◀

 The types of bulb fitted to your motorcycle are listed in the section entitled "Technical data". ◀

 Do not touch the glass of new bulbs with your fingers. Use a clean, dry cloth to hold the bulbs when handling them. Dirt deposits, in particular oil and grease, interfere with heat radiation from the bulb. This leads to overheating and shortens the bulb's operating life. ◀

Replacing low-beam and high-beam headlight bulb

 If it is not standing firmly, the motorcycle could topple in the course of the operations described below.

Always make sure that the motorcycle is stable and firmly supported. ◀

with OE Xenon lights:

 Xenon lights operate with high voltage; incorrect working procedures can result in fatalities.

Have all work on the xenon light system, including the work involved in replacing bulbs, performed by a specialist workshop, preferably by an authorised BMW Motorrad dealer. ◀

- For the time being, ride with the high-beam headlight switched on.
- In order not to dazzle oncoming traffic, set the headlight beam throw adjuster to the position for riding with maximum payload.
- Have the bulb replaced as soon as possible by a specialist workshop, preferably an authorised BMW Motorrad dealer. ◀

- Make sure the ground is level and firm and place the motorcycle on its stand.
- Switch off the ignition.

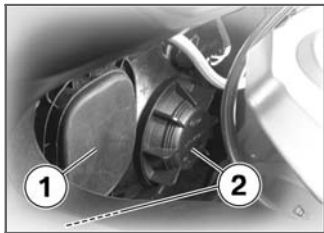

- Remove cover **1** (low-beam headlight) or covers **2** (high-beam headlight).
- Remove the covers of the high-beam headlight bulbs by turning them counter-clockwise.

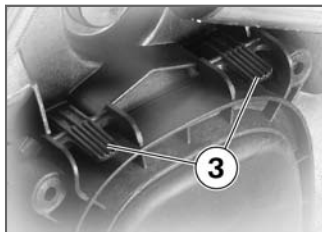

- To remove the cover of the low-beam headlight bulb, push locking lever **3** down, swing the cover down and remove.

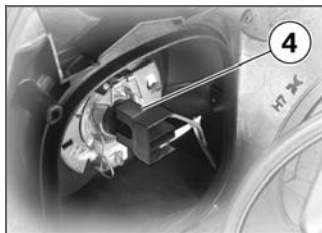

- Disconnect plug **4**.

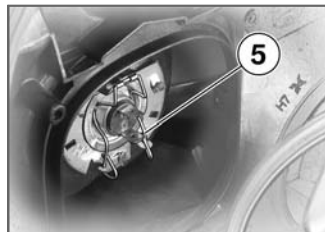

- Disengage spring clip **5** from the latches and swing it up.

▶ The spring clip might face in a direction other than that shown here, depending on the light.◀

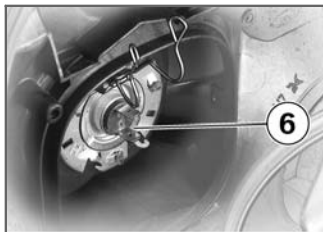

- Remove bulb **6**.
- Replace the defective bulb.

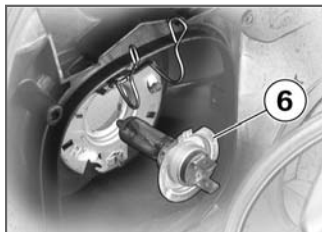

- Install bulb **6**.

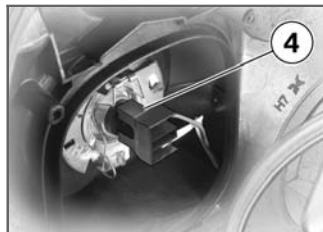

- Connect plug **4**.

	Bulb for high-beam headlight
– H7 / 12 V / 55 W	

	Bulb for low-beam headlight
– H7 / 12 V / 55 W	
with OE Xenon lights:	
– D2R / 35 W	

- Use a clean, dry cloth to hold the new bulb.

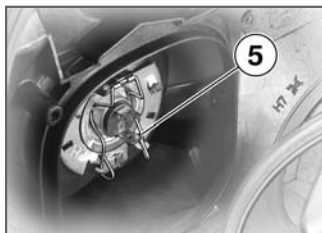

- Close and lock spring clips **5**.

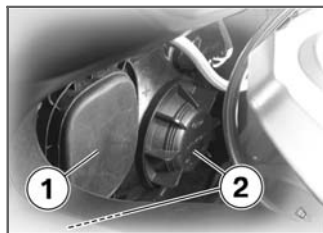

- Install cover **1** (low-beam headlight) or covers **2** (high-beam headlight).

Replacing parking-light bulbs

! If it is not standing firmly, the motorcycle could topple in the course of the operations described below.

Always make sure that the motorcycle is stable and firmly supported. ◀

- Make sure the ground is level and firm and place the motorcycle on its stand.
- Switch off the ignition.



- Parking light, right: disconnect plug **1**.



- Parking light, left: disconnect plug **2**.

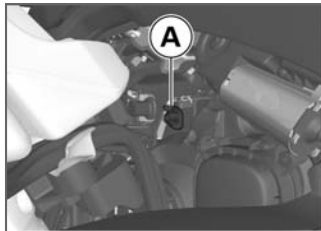

- Remove the bulb socket by turning lever **A** counter-clockwise.

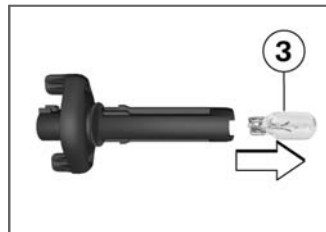

- Remove bulb **3** from the bulb holder.
- Replace the defective bulb.

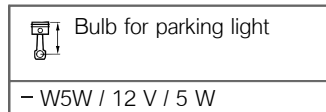

- Use a clean, dry cloth to hold the new bulb.

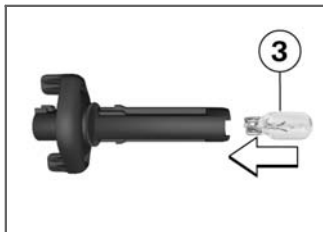

- Insert bulb **3** into the bulb socket.
- Turn the bulb socket clockwise to install.



- Parking light, right: connect plug **1**.

Replacing brake-light, rear light and rear-indicator bulbs

 If it is not standing firmly, the motorcycle could topple in the course of the operations described below.

Always make sure that the motorcycle is stable and firmly supported. ◀

- Make sure the ground is level and firm and place the motorcycle on its stand.

- Switch off the ignition.

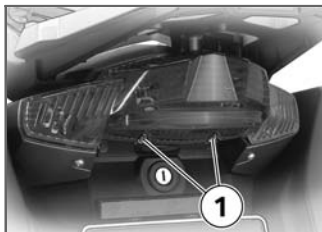

- Remove screws **1**.
- Pull the bulb housing to the rear until it is clear of the holders.

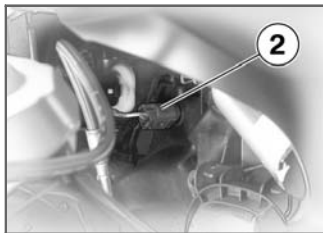

- Parking light, left: connect plug **2**.

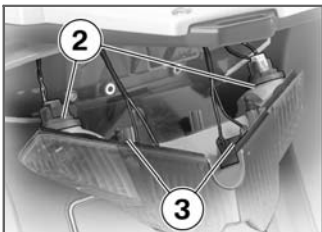

- Turn bulb socket **2** (brake-light /rear-light bulb) or **3** (indicator bulb) counter-clockwise to remove from the bulb housing.

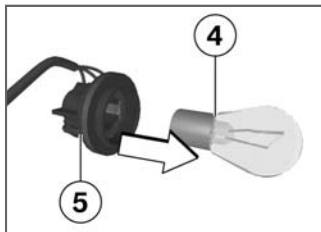

- Press bulb **4** into socket **5** and remove by turning it counter-clockwise.
- Replace the defective bulb.



Bulb for tail light/brake light

– P21W / 12 V / 21 W



Bulbs for flashing turn indicators, rear

– P21W / 12 V / 21 W

- Use a clean, dry cloth to hold the new bulb.

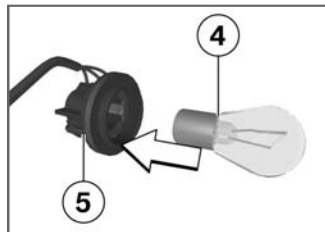

- Press bulb **4** into socket **5** and turn it clockwise to install.

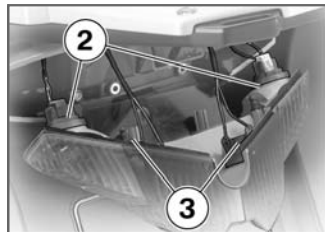

- Turn bulb socket **2** (indicator bulb) or **3** (brake-light /rear-light bulb) clockwise to install it in the bulb housing.

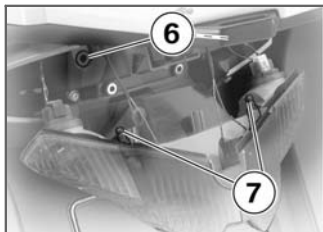

- Seat retaining pins **7** of the bulb housing in retainers **6**. Make sure that the wires are not trapped.

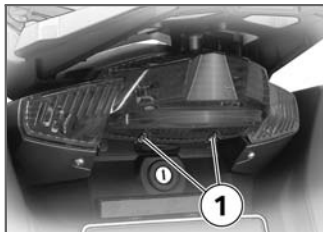

- Install screws **1**.

Replacing front turn indicator bulbs

! If it is not standing firmly, the motorcycle could topple in the course of the operations described below. Always make sure that the motorcycle is stable and firmly supported. ◀

- Make sure the ground is level and firm and place the motorcycle on its stand.
- Switch off the ignition.



- Remove screw **1**.

- Pull the bulb housing forward to remove

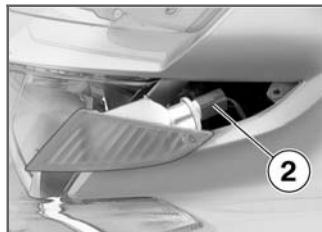

- Disconnect plug **2**.



- Turn bulb holder **3** counter-clockwise to remove it from the bulb housing.

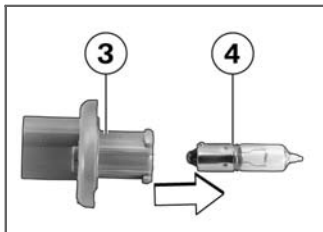

- Press bulb **4** into bulb housing **3** and remove by turning it counter-clockwise.
- Replace the defective bulb.

 Bulbs for flashing turn indicators, front

– H21W / 12 V / 21 W

- Use a clean, dry cloth to hold the new bulb.

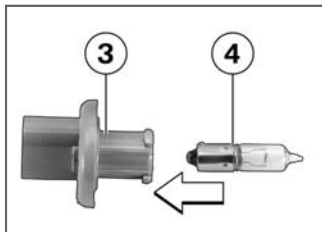

- Press bulb **4** into socket **3** and turn it clockwise to install.



- Turn bulb socket **3** clockwise to install it in the bulb housing.

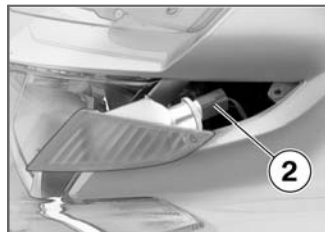

- Connect plug **2**.



- Seat the bulb housing in the fairing.
- Install screw **1**

Jump starting



The wires leading to the power socket do not have a load-capacity rating adequate for jump-starting the engine. Excessively high current can lead to a cable fire or damage to the vehicle electronics.

Do not use the on-board socket to jump-start the engine of the motorcycle. ◀



Touching live parts of the ignition system with the engine running can cause electric shock.

Do not touch parts of the ignition system when the engine is running. ◀



A short-circuit can result if the crocodile clips of the jump leads are accidentally brought into contact with the motorcycle.

Use only jump leads fitted with

fully insulated crocodile clips at both ends. ◀



Jump-starting with a donor-battery voltage higher than 12 V can damage the vehicle electronics.

Make sure that the battery of the donor vehicle has a voltage rating of 12 V. ◀

- When jump-starting the engine, do not disconnect the battery from the on-board electrical system.
- Remove the battery-compartment cover (➡ 133)
- Run the engine of the donor vehicle during jump-starting.
- Begin by connecting one end of the red jump lead to the positive terminal of the discharged battery and the other end to the positive terminal of the donor battery.
- Then connect one end of the black jump lead to the negative

terminal of the donor battery, and the other end to the negative terminal of the discharged battery.

- Start the engine of the vehicle with the discharged battery in the usual way; if the engine does not start, wait a few minutes before repeating the attempt in order to protect the starter motor and the donor battery.
- Allow both engines to idle for a few minutes before disconnecting the jump leads.
- Disconnect the jump lead from the negative terminals first, then disconnect the second lead from the positive terminals.
- Install the battery-compartment cover (➡ 134)

Battery

Maintenance instructions

Correct upkeep, recharging and storage will prolong the life of the battery and are essential if warranty claims are to be considered.

Compliance with the points below is important in order to maximise battery life:

- Keep the surface of the battery clean and dry
- Do not open the battery
- Do not top up with water
- Be sure to read and comply with the instructions for charging the battery on the following pages
- Do not turn the battery upside down

 If the battery is not disconnected, the on-board electronics (e.g. clock, etc.) gradually drain the battery. This can cause the battery to run flat. If this hap-

pens, warranty claims will not be accepted.

If the motorcycle is to be out of use for more than four weeks, disconnect the battery or connect a suitable trickle charger to the battery.◀

 BMW Motorrad has developed a float charger specially designed for compatibility with the electronics of your motorcycle. Using this charger, you can keep the battery charged during long periods of disuse, without having to disconnect the battery from the motorcycle's on-board systems. You can obtain additional information from your authorised BMW Motorrad dealer.◀

Charging battery when connected

 Charging the connected battery directly at the battery terminals can damage the vehicle electronics.

Always disconnect the battery from the on-board circuits before recharging it with a charger connected directly to the battery posts.◀

 If you switch on the ignition and the multifunction display and telltale lights fail to light up, the battery is completely flat. Attempting to charge a completely flat battery via the on-board socket can cause damage to the motorcycle's electronics. If a battery has discharged to the extent that it is completely flat, it has to be disconnected from the on-board circuits and charged with the charger connected directly to the battery posts.◀

 Only chargers suitable for this mode of charging can be used to recharge the battery via the on-board socket. Unsuitable chargers could cause damage to the motorcycle's on-board electrics.

Use BMW chargers with the part numbers 71 60 7 688 864 (220 V) or, as applicable, 71 60 7 688 865 (110 V). If you are in doubt, disconnect the battery from the on-board systems and connect the charger directly to the battery.◀

- Charge via the power socket, with the battery connected to the motorcycle's on-board electrical system.

 The motorcycle's on-board electronics know when the battery is fully charged. The on-board socket is switched off when this happens.◀

- Comply with the operating instructions of the charger.

 If you are unable to charge the battery through the on-board socket, you may be using a charger that is not compatible with your motorcycle's electronics. If this happens, disconnect the battery from the on-board systems and connect the charger directly to the battery.◀

Charging battery when disconnected

- Charge the battery using a suitable charger.
- Comply with the operating instructions of the charger.
- Once the battery is fully charged, disconnect the charger's terminal clips from the battery terminals.

 The battery has to be recharged at regular intervals in the course of a lengthy period of disuse. See the instructions

for caring for your battery. Always fully recharge the battery before restoring it to use.◀

Removing battery-compartment cover

 If it is not standing firmly, the motorcycle could topple in the course of the operations described below.

Always make sure that the motorcycle is stable and firmly supported.◀

- Make sure the ground is level and firm and place the motorcycle on its stand.

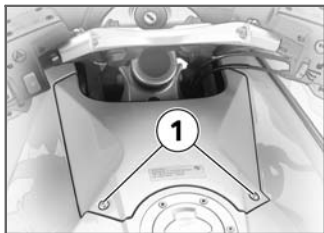

- Remove screws **1**.
- Lift the battery compartment cover up and back to remove.

Installing battery-compartment cover

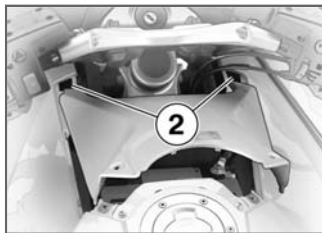

- Place the battery-compartment cover in mounts **2**

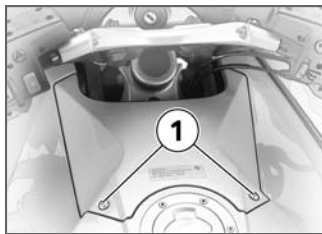

- Install screws **1**.

Removing battery

- Remove the battery-compartment cover (→ 133)

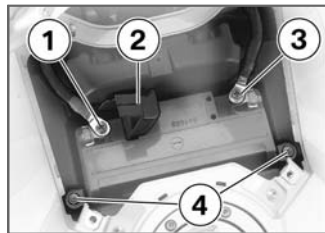

⚠ Disconnection in the wrong sequence increases the risk of short-circuits. Always proceed in the correct sequence. ◀

- Disconnect negative lead **3** first.
- Remove protective cap **2** from the positive terminal.
- Then disconnect positive lead **1**.

- Remove screws **4** and pull the retainer to the rear.
- Lift the battery up and out; work it slightly back and forth if it is difficult to remove.

Installing battery

- Switch off the ignition.
- Place the battery in the battery compartment, positive terminal on the left in the forward direction of travel.

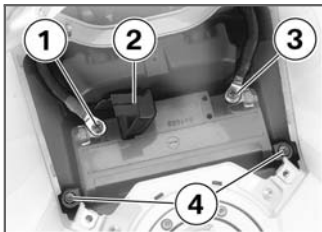

- Slip the battery retainer over the battery and install screws **4**.



Installation in the wrong sequence increases the risk of short-circuits.

Always proceed in the correct sequence.

Never install the battery without the protective cap.◀

- Connect battery positive lead **1** first.
- Seat protective cap **2** on the positive terminal.
- The connect battery negative lead **3**.
- Switch on the ignition.

▶ If the battery was disconnected from the motorcycle for a prolonged period of time it will be necessary to enter the current date in the instrument cluster, in order to ensure that the service-due indicator functions correctly.

If you want to have the date set consult a specialist workshop,

preferably an authorised BMW Motorrad dealer.◀

- Fully open the throttle once or twice.
- » The engine management system registers the throttle-valve position.
- Install the battery-compartment cover (➡ 134)
- Set the clock (➡ 49)

Care

Care products	138
Washing motorcycle	138
Cleaning easily damaged components.....	138
Paint care	139
Protective wax coating	140
Laying up the motorcycle	140
Restoring motorcycle to use	140

Care products

BMW Motorrad recommends that you use the cleaning and care products you can obtain from your authorised BMW Motorrad dealer. The substances in BMW Care Products have been tested in laboratories and in practice; they provide optimised care and protection for the materials used in your vehicle.

 The use of unsuitable cleaning and care products can damage vehicle components. Do not use solvents such as cellulose thinners, cold cleaners, fuel or the like, and do not use cleaning products that contain alcohol.◀

Washing motorcycle

BMW Motorrad recommends that you use BMW insect remover to soften and wash off insects and stubborn dirt on

painted parts prior to washing the motorcycle.

To prevent stains, do not wash the motorcycle immediately after it has been exposed to strong sunlight and do not wash it in the sun.

Make sure that the motorcycle is washed frequently, especially during the winter months.

To remove road salt, clean the motorcycle with cold water immediately after every trip.

 After the motorcycle has been washed, ridden through water or ridden in the rain, the brake discs and pads might be wet and the brakes might not take effect immediately.

Apply the brakes in good time until the brakes have dried out.◀

 Warm water intensifies the effect of salt.

Use only cold water to wash off road salt.◀

 The high pressure of steam cleaners can damage seals, the hydraulic brake system, the electrical system, and the seat. Do not use a steam jet or high-pressure cleaning equipment.◀

Cleaning easily damaged components

Plastics

Clean plastic parts with water and BMW plastic care emulsion. This includes in particular:

- Windscreen and slipstream deflectors
- Headlight lens made of plastic
- Glass cover of the instrument cluster
- Black, unpainted parts

 If plastic parts are cleaned using unsuitable cleaning

agents, the surfaces can be damaged.

Do not use cleaning agents that contain alcohol, solvents or abrasives to clean plastic parts.

Even fly-remover pads or cleaning pads with hard surfaces can produce scratches.◀

 Soften stubborn dirt and insects by covering the affected areas with a wet cloth.◀

Windscreen

Clean off dirt and insects with a soft sponge and plenty of water.

 Fuel and chemical solvents attack the material of the windscreen; the windscreen becomes opaque or dull.

Do not use cleaning agents.◀

Chrome

Use plenty of water and BMW shampoo to clean chrome, particularly if it has been exposed to road salt. Use chrome polish for additional treatment.

Radiator

Clean the radiator regularly to prevent overheating of the engine due to inadequate cooling. For example, use a garden hose with low water pressure.

 Cooling fins can be bent easily.

Take care not to bend the fins when cleaning the radiator.◀

Rubber

Treat rubber components with water or BMW rubber-care products.

 Using silicone sprays for the care of rubber seals can cause damage.

Do not use silicone sprays or other care products that contain silicon.◀

Paint care

Washing the motorcycle regularly will help counteract the long-term effects of substances that damage the paint, especially if your motorcycle is ridden in areas with high air pollution or natural sources of dirt, for example tree resin or pollen.

Remove particularly aggressive substances immediately, however, as otherwise the paint can be affected or become discoloured. Substances of this nature include spilt fuel, oil, grease, brake fluid and bird droppings. We recommend BMW vehicle polish or BMW paint cleaner for this purpose.

Marks on the paintwork are particularly easy to see after the motorcycle has been washed.

Remove stains of this kind immediately, using cleaning-grade benzene or petroleum spirit on a clean cloth or ball of cotton wool. BMW Motorrad recommends BMW tar remover for removing specks of tar. Remember to wax the parts treated in this way.

Protective wax coating

BMW Motorrad recommends applying only BMW car wax or products containing carnauba wax or synthetic wax.

It is time to rewax the paintwork when water "puddles" on the surface, instead of forming beads.

Laying up the motorcycle

- Clean the motorcycle.
- Remove the battery.
- Spray the brake and clutch lever pivots and the main and

side stand pivots with a suitable lubricant.

- Coat bright metal and chrome-plated parts with an acid-free grease (e.g. Vaseline).
- Stand the motorcycle in a dry room in such a way that there is no load on either wheel.

 Before laying the vehicle up out of use, have the engine oil and the oil filter element changed by a specialist workshop, preferably an authorised BMW Motorrad dealer. Combine work for laying up/restoring to use with a BMW service or inspection.◀

Restoring motorcycle to use

- Remove the protective wax coating.
- Clean the motorcycle.
- Install a charged battery.

- Before starting: work through the checklist.

Technical data

Troubleshooting chart	142	Riding specifications	153
Threaded fasteners	143		
Engine	145		
Fuel.....	146		
Engine oil	146		
Clutch	147		
Transmission	147		
Rear-wheel drive.....	148		
Running gear	148		
Brakes	149		
Wheels and tyres	149		
Electrics	150		
Frame	152		
Dimensions	152		
Weights.....	153		

Troubleshooting chart

Engine does not start at all or is difficult to start.

Possible cause	Remedy
Kill switch activated.	Kill switch in operating position (run).
Side stand extended and gear engaged.	Retract the side stand (➡ 80).
Gear engaged and clutch not disengaged	Select neutral or pull clutch lever (➡ 80).
Clutch pulled when ignition was OFF	Switch on the ignition, then pull the clutch lever.
No fuel in tank.	Refuelling (➡ 87)
Battery not adequately charged.	Charge the battery when connected (➡ 132)

Threaded fasteners

Front wheel	Value	Valid
Front brake caliper to wheel carrier		
M8 x 32 - 10.9	30 Nm	
Clamping screw for quick-release axle in wheel carrier		
M8 x 30	19 Nm	
Quick-release axle in threaded bush		
M24 x 1.5	50 Nm	
Rear wheel	Value	Valid
Silencer to rear footrest		
M8 x 30	22 Nm	
Silencer to manifold		
M8 x 60 - 10.9	35 Nm	
Rear wheel to wheel flange		
M10 x 1.25 x 40	tighten in diagonally opposite sequence	
	60 Nm	

Handlebars	Value	Valid
Fastener, handlebar adjuster to bottom handlebar yoke		
M8	20 Nm	

Engine

Engine design	Transversely mounted, four-cylinder four-stroke in-line engine tilted 55° forward, DOHC with chain-and-sprocket drive, four valves per cylinder with cam followers, liquid cooled cylinders and heads, integrated coolant pump, electronic fuel injection, integrated six-speed cassette gearbox, dry-sump lubrication.
Displacement	1157 cm ³
Cylinder bore	79 mm
Piston stroke	59 mm
Compression ratio	13:1
Nominal output	112 kW, - at engine speed: 9500 min ⁻¹
with OE Reduced power output, 79 kW:	79 kW, - at engine speed: 8500 min ⁻¹
Torque	130 Nm, - at engine speed: 7750 min ⁻¹
with OE Reduced power output, 79 kW:	111 Nm, - at engine speed: 5000 min ⁻¹
Maximum engine speed	max 10000 min ⁻¹
Idle speed	1050±50 min ⁻¹

Fuel

Recommended fuel grade	98 ROZ/RON, Premium plus unleaded 95 ROZ/RON, Premium unleaded (fuel grade, usable with power- and consumption-related restrictions)
Usable fuel capacity	24 l
Reserve fuel	≥4 l

Engine oil

Engine oil capacity, total	3.5 l, with filter change 0.5 l, Difference between MIN / MAX marks
Lubricant	Castrol GPS 10W-40 (SAE 10W40; API SG; JASO MA)
Oil grades	Mineral oils of API classification SF through SH. BMW Motorrad recommends not using oil additives, because they can have a detrimental effect on clutch operation. Please do not hesitate to contact your authorised BMW Motorrad dealer if you have any questions relating the choice of a suitable engine oil for your motorcycle.

Permissible viscosity classes

SAE 10 W-40	≥ -20 °C, Operation at low temperatures
SAE 15 W-40	≥ -10 °C

Clutch

Clutch type	Multiplate clutch running in oil bath
-------------	---------------------------------------

Transmission

Gearbox type	Claw-shift 6-speed cassette gearbox, integrated into engine block
Gearbox transmission ratios	1.559 (92:59 teeth), Primary transmission ratio 2.294 (39:17 teeth), 1st gear 1.789 (34:19 teeth), 2nd gear 1.458 (35:24 teeth), 3rd gear 1.240 (31:25 teeth), 4th gear 1.094 (35:32 teeth), 5th gear 0.971 (33:34 teeth), 6th gear 1.045 (23:22 teeth), Angular drive

Rear-wheel drive

Type of final drive	Shaft drive with bevel gears
Type of rear suspension	BMW EVO Paralever; cast light-alloy single swinging arm with two joints and torque reaction link
Gear ratio of final drive	2.82

Running gear

Type of front suspension	Double leading link
Spring travel, front	125 mm, At wheel
Type of rear suspension	Central spring strut pivoted to lever system with coil spring and single-tube gas-filled shock absorber. Spring preload steplessly hydraulically adjustable, rebound stage damping steplessly adjustable.
with OE Electronic Suspension Adjustment (ESA):	Central spring strut pivoted to lever system with coil spring and single-tube gas-filled shock absorber. Spring basic setting three-way adjustable, compression and rebound stages each three-way adjustable
Spring travel, rear	135 mm, At wheel

Brakes

Type of front brake	Hydraulically operated twin disc brake with 4-piston fixed calipers and floating brake discs
Brake-pad material, front	Sintered metal
Type of rear brake	Hydraulically operated disc brake with 2-piston floating caliper and fixed disc
Brake-pad material, rear	Organic material

Wheels and tyres

Tyre combinations recommended at time of going to press (As at: 09.05.2007)	Front: Bridgestone, BT 020 F UU Radial, 120/70 ZR17 M/C (58W) Rear: Bridgestone, BT 020 R UU Radial, 180/55 ZR17 M/C (73W)
	Front: Metzeler, Roadtec Z6 C, 120/70 ZR17 M/C (58W) Rear: Metzeler, Roadtec Z6 K, 180/55 ZR17 M/C (73W)

Front wheel

Front wheel, type	Cast aluminium, MT H2
Front wheel rim size	3.50" x 17"
Tyre designation, front	120/70 ZR 17

Rear wheel

Rear wheel type	Cast aluminium, MT H2
Rear wheel rim size	5.50" x 17"
Tyre designation, rear	180/55 ZR 17

Tyre pressure

Tyre pressure, front	2.5 bar, one-up, tyre cold 2.5 bar, two-up and/or with luggage, tyre cold
Tyre pressure, rear	2.9 bar, one-up, tyre cold 2.9 bar, two-up and/or with luggage, tyre cold

Electrics

Electrical rating of on-board socket	8 A, One on-board socket
with OE (Additional) socket:	8 A, Total for all sockets
Fuses	All circuits are electronically protected, so plug-in fuses are no longer necessary. If an electronic fuse trips and de-energises a circuit, the circuit is active as soon as the ignition is switched on after the fault has been rectified.

Battery

Battery, manufacturer and designation	GEL 19
Battery type	Gel battery
Battery rated voltage	12 V
Battery rated capacity	19 Ah

Technical data

Spark plugs, manufacturer and designation	NGK KR9CI
Electrode gap of spark plug	0.8 mm

Lighting

Bulb for high-beam headlight	H7 / 12 V / 55 W
Bulb for low-beam headlight	H7 / 12 V / 55 W
with OE Xenon lights:	D2R / 35 W
Bulb for parking light	W5W / 12 V / 5 W
Bulb for tail light/brake light	P21W / 12 V / 21 W
Bulbs for flashing turn indicators, front	H21W / 12 V / 21 W
Bulbs for flashing turn indicators, rear	P21W / 12 V / 21 W

Frame

Frame type	Light alloy weldment with bolt-on tubular steel rear frame
Type plate location	Frame cross-tube, rear
VIN location	Frame side section, front right

Dimensions

Length of motorcycle	2318 mm
Width of motorcycle	982 mm, Across mirrors
Height of motorcycle	1438 mm, At DIN unladen weight
Front-seat height	820 mm, Without rider
with OE Front seat, low:	800 mm, Without rider

Weights

Unladen weight	288 kg, DIN unladen weight, ready for road, 90 % load of fuel, without optional extras
Permissible gross weight	520 kg
Maximum payload	max 238 kg

Riding specifications

Top speed	>200 km/h
-----------	-----------

Service

BMW Motorrad service	156
BMW Motorrad service quality	156
BMW Motorrad Service Card: on-the-spot breakdown assistance	156
BMW Motorrad service network ...	157
Maintenance work	157
Confirmation of maintenance work	158
Confirmation of service	163

BMW Motorrad service

Advanced technology requires specially adapted methods of maintenance and repair.



If maintenance and repair work is performed inexpertly, it could result in consequential damage and thus constitute a safety risk.

BMW Motorrad recommends you to have all the associated work on your motorcycle carried out by a specialist workshop, preferably an authorised BMW Motorrad dealer. ◀

Your authorised BMW Motorrad dealer can provide information on BMW services and the work undertaken as part of each service. Have all maintenance and repair work carried out confirmed in the "Service" chapter in this manual. Authorised BMW Motorrad dealers are supplied with the latest technical information and have

the necessary technical know-how. BMW Motorrad recommends that you contact your authorised BMW Motorrad dealer if you have questions regarding your motorcycle.

BMW Motorrad service quality

Along with its reputation for engineering quality and high reliability, BMW Motorrad is a byword for excellent quality of service. To ensure that your BMW is always in optimum condition, BMW Motorrad recommends that you have the maintenance work required for your motorcycle carried out regularly, preferably by your authorised BMW Motorrad dealer. For generous treatment of claims submitted after the warranty period has expired, evidence of regular maintenance is essential.

Certain signs of wear, moreover, may otherwise not be noticed until it is too late to put them right at moderate cost. Your authorised BMW Motorrad dealer's mechanics know every detail of your motorcycle and can take remedial action if necessary before minor faults develop into serious problems. By having the necessary repairs done properly and in good time, you save time and money in the long run.

BMW Motorrad Service Card: on-the-spot breakdown assistance

In the event of a breakdown, the BMW Motorrad Service Card issued with each new BMW motorcycle enables you to access an extensive range of services such as breakdown assistance, motorcycle transportation etc. (details can differ from country to country). In the event of a break-

down, contact BMW Motorrad's Mobile Service. The specialists will provide the necessary advice and assistance.

You will find important country-specific contact addresses and the after-sales service organisation phone numbers in the "Service Kontakt / Service Contact" brochures, along with information on Mobile Service and the dealership network.

BMW Motorrad service network

BMW Motorrad has an extensive after-sales service network in place to look after you and your motorcycle in more than 100 countries. In Germany alone, you have the best possible access to approximately 200 authorised BMW Motorrad dealers.

All information concerning the international dealership network can be found in the brochure

"Service Contact Europe" or "Service Contact Africa, America, Asia, Australia, Oceania".

Maintenance work

BMW Pre-delivery Check

Your authorised BMW Motorrad dealer conducts the BMW pre-delivery check before handing over the motorcycle to you.

BMW Running-in Check

The BMW running-in check has to be performed when the motorcycle has covered between 500 km and 1,200 km

BMW Service

The BMW Service is carried out once a year; the extent of servicing can vary, depending on the age of the motorcycle and the distance it has covered. Your authorised BMW Motorrad dealer confirms that the service work has been carried out and enters

the date when the next service will be due.

Riders who cover long distances in a year might have to bring in their motorcycles for service before the next scheduled date. It is to allow for these cases that a maximum odometer reading is entered as well in the confirmation of service. Servicing has to be brought forward if this odometer reading is reached before the next scheduled date for the annual service.

The service-due indicator in the multifunction display reminds you about one month or 1000 km in advance when the time for a service is approaching, on the basis of the programmed values.

Confirmation of maintenance work

BMW Pre-delivery Check

Completed

on _____

Stamp, signature

BMW Running-in Check

Completed

on _____

Odometer reading _____

Next service
at the latest

on _____

or, if logged beforehand,

Odometer reading _____

Stamp, signature

BMW Service

Completed

on _____

Odometer reading _____

Next service
at the latest

on _____

or, if logged beforehand,

Odometer reading _____

Stamp, signature**BMW Service**

Completed

on _____

Odometer reading _____

Next service
at the latest

on _____

or, if logged beforehand,

Odometer reading _____

Stamp, signature**BMW Service**

Completed

on _____

Odometer reading _____

Next service
at the latest

on _____

or, if logged beforehand,

Odometer reading _____

Stamp, signature

BMW Service

Completed

on _____

Odometer reading _____

Next service
at the latest

on _____

or, if logged beforehand,

Odometer reading _____

Stamp, signature**BMW Service**

Completed

on _____

Odometer reading _____

Next service
at the latest

on _____

or, if logged beforehand,

Odometer reading _____

Stamp, signature**BMW Service**

Completed

on _____

Odometer reading _____

Next service
at the latest

on _____

or, if logged beforehand,

Odometer reading _____

Stamp, signature

BMW Service

Completed

on _____

Odometer reading _____

Next service
at the latest

on _____

or, if logged beforehand,

Odometer reading _____

Stamp, signature**BMW Service**

Completed

on _____

Odometer reading _____

Next service
at the latest

on _____

or, if logged beforehand,

Odometer reading _____

Stamp, signature**BMW Service**

Completed

on _____

Odometer reading _____

Next service
at the latest

on _____

or, if logged beforehand,

Odometer reading _____

Stamp, signature

BMW Service

Completed

on _____

Odometer reading _____

Next service
at the latest

on _____

or, if logged beforehand,

Odometer reading _____

Stamp, signature**BMW Service**

Completed

on _____

Odometer reading _____

Next service
at the latest

on _____

or, if logged beforehand,

Odometer reading _____

Stamp, signature**BMW Service**

Completed

on _____

Odometer reading _____

Next service
at the latest

on _____

or, if logged beforehand,

Odometer reading _____

Stamp, signature

Confirmation of service

The table is intended as a record of maintenance, warranty and repair work, the installation of optional accessories and, if appropriate, special campaign (recall) work.

Item	Odometer reading	Date

A

Abbreviations and symbols, 6

ABS

Self-diagnosis, 82

Warnings, 32

Accessories

General instructions, 97

Anti-theft alarm, 18

Warnings, 41

ASC

Self-diagnosis, 82

Switching off, 61

Switching on, 61, 62

Warnings, 34

B

Battery

Battery compartment, 11

Charging battery when connected, 132

Charging battery when disconnected, 133

Installation, 135

Technical data, 151

Warning, battery charge current, 28

Beam throw, 13

Brake fluid

Checking level, front, 13

Checking level, rear, 15

Test, 111

Brake pads

Running in, 83

Test, 109

Brakes

Adjust the handbrake lever, 67

Technical data, 149

Bulbs

General instructions, 123

Replacing brake-light bulb, 127

Replacing front turn indicator bulbs, 129

Replacing high-beam headlight bulb, 123

Replacing low-beam headlight bulb, 123

Replacing parking-light bulbs, 126

Replacing rear light bulb, 127

Replacing rear-indicator bulbs, 127

Technical data, 151

Warning, bulb failure, 29, 30

C

Care, 137

Case

Closing, 100

Installing, 101

Opening, 100

Removing, 101

Checklist, 80

Clock

Adjusting, 18, 49

Clutch

Adjusting clutch lever, 66

Technical data, 147

Confirmation of maintenance work, 158

Coolant

Temperature gauge, 22

Cruise-control system, 16

Operation, 63

Telltale light, 25

Currency, 7

D

Damping

Adjusting for rear wheel, 69

Dimensions

Technical data, 152

E

Electrics

Technical data, 150

Emergency off switch (kill switch), 17, 58

Engine

Starting, 80

Technical data, 145

Warning, engine electronics, 27

Engine oil

Filler neck, 15

Oil dipstick, 15

Technical data, 146

Test, 107

Topping up, 107

Warning, engine oil level, 32

Warning, engine oil pressure, 28

Equipment, 7

ESA, 16, 69

Adjust spring preload, 71

Adjust suspension damping, 71

Call up the settings, 70

EWS, 48

Warning, 27

F

Frame

Technical data, 152

Front seat

Adjusting, 15

Heating, 17

Front-wheel stand

Installing, 121

Fuel

Quantity reading, 22

Refuelling, 87

Technical data, 146

Warning, fuel down to reserve, 27

Fuses, 150

G

Gear indicator, 22

Grip heating, 17, 59

H

Handlebar fittings

General view, left side, 16

General view, right side, 17

Handlebars

Adjusting, 67

Hazard warning flashers, 16, 17

Switching off, 58

Switching on, 57

Headlight

Adjustment for driving on left/
driving on right, 72

Beam throw, 73

High-beam headlight, 19

Low-beam headlight, 19

Side lights, 19

Helmet holder, 15, 76

High-beam headlight, 16

Horn, 16

I

- Ignition
 - Switching off, 47
 - Switching on, 47
- Immobiliser, 48
 - Warning, 27
- Instrument cluster
 - Overview, 18
 - Sensor for lighting, 18

J

- Jump starting, 131

K

- Keys, 47

L

- Laying up, 140
- Lights
 - Headlight flasher, 56
 - High-beam headlight, 56
 - Low-beam headlight, 56
 - Parking light, 56
 - Side light, 55
- Luggage
 - Correct loading, 99

M

- Maintenance
 - General instructions, 106
- Mirrors
 - Adjusting, 68
- Motorcycle
 - Restoring to use, 140
- Multifunction display, 18
 - Adjust the dimmer, 51
 - Overview, 22

O

- Odometer and tripmeters
 - Resetting, 50
 - Selecting readings, 49
- On-board computer, 17
 - Ambient temperature, 52
 - Average consumption, 53
 - Average speed, 53
 - Oil level, 54
 - Range, 52
 - Reset the average consumption, 53
 - Resetting average speed, 53

- Selecting readings, 51
- Warnings, 30

P

- Parking, 85
- Power socket, 11, 98
- Pre-ride check, 81

R

- Rear-wheel drive
 - Technical data, 148
- Refuelling, 87
 - Filler neck, 13
- Reserve
 - Warning, 27
- Residual range, 50
- Restoring to use, 140
- Rev. counter, 18
- Rider's Manual, 15
- Running gear
 - Technical data, 148
- Running in, 83

S

- Safety instructions, 77

- Seat, 15
 - Adjust the seat height, 62
- Seat heating, 60
- Seat lock, 11
- Seats
 - Install the front seat, 75
 - Install the rear seat, 75
 - Remove the front seat, 74
 - Remove the rear seat, 73
- Service, 156
 - Status indicators on the display, 22
- Service Card, 156
- Side stand
 - For starting, 80
- Spark plugs, 151
- Speedometer, 18
- Spring preload
 - Adjusting for rear wheel, 68
- Spring preload, rear
 - Adjusting, 11
- Starter, 17
- Starting, 80
- Steering lock
 - Locking, 48
- Stowage compartment, 13, 66
- Suspension damping, rear
 - Adjusting, 11
- T**
- Technical data
 - Battery, 151
 - Brakes, 149
 - Bulbs, 151
 - Clutch, 147
 - Dimensions, 152
 - Electrics, 150
 - Engine, 145
 - Engine oil, 146
 - Frame, 152
 - Fuel, 146
 - Rear-wheel drive, 148
 - Running gear, 148
 - Spark plugs, 151
 - Standards, 7
 - Transmission, 147
 - Weights, 153
- Wheels and tyres, 149
- Telltale lights, 18
- Toolkit, 15
 - Service kit, 106
 - Standard kit, 106
- Topcase
 - Closing, 102
 - Installing, 103
 - Opening, 102
 - Removing, 103
- Torques, 141
- Transmission
 - For starting, 80
 - Technical data, 147
- Troubleshooting chart, 142
- Turn indicators
 - Left, 16
 - Right, 17
 - Switching off, 17, 57
 - Switching on left, 56
 - Switching on right, 57

Tyre pressure monitoring RDC
Label on wheel rim, 114
Operation, 54
Status indicators, 54
Warnings, 36

Tyres
Approved, 114
Checking tread depth, 113
Checking tyre pressures, 72
Running in, 83
Technical data, 149

V

Vehicle
Cleaning, 137
General view, left side, 11
General view, right side, 13
Laying up, 140
Parking, 85
Vehicle identification number, 13

W

Warning lights, 18

Warnings, 25
ABS, 32
ASC, 34
DWA, 41
Mode of presentation, 25
On-board computer, 30
RDC, 36
Warnings, overview, 26, 31, 33,
35, 38, 42
Weights
Technical data, 153
Wheels
Installing front wheel, 116
Installing rear wheel, 119
Remove the front wheel, 114
Removing rear wheel, 118
Technical data, 149
Windscreen, 11
Adjusting, 16, 63

Details described or illustrated in this booklet may differ from the motorcycle's actual specification as purchased, the accessories fitted or the national-market specification. No claims will be entertained as a result of such discrepancies.

Dimensions, weights, fuel consumption and performance data are quoted to the customary tolerances.

The right to modify designs, equipment and accessories is reserved.

Errors and omissions excepted.

© 2007 BMW Motorrad

Not to be reproduced either wholly or in part without written permission from BMW Motorrad, After Sales.

Printed in Germany.

The most important data for a filling-station stop can be found in the following chart:

Fuel	
Recommended fuel grade	98 ROZ/RON, Premium plus unleaded 95 ROZ/RON, Premium unleaded (fuel grade, usable with power- and consumption-related restrictions)
Usable fuel capacity	24 l
Reserve fuel	≥4 l
Tyre pressure	
Tyre pressure, front	2.5 bar, one-up, tyre cold 2.5 bar, two-up and/or with luggage, tyre cold
Tyre pressure, rear	2.9 bar, one-up, tyre cold 2.9 bar, two-up and/or with luggage, tyre cold

BMW recommends 

Order No. 01 41 7 712 141
07.2007, 3rd edition

